

TSC 13-1, January 2013

Inspector's Manual for Hot-Mixed Asphalt and Portland Cement Concrete Pavement Construction



Contents

| | |
|-------------------------------------|----|
| CHAPTER 1 INTRODUCTION | 1 |
| 1-1 OVERVIEW..... | 1 |
| 1-2 PURPOSE..... | 2 |
| 1-3 FORMAT..... | 2 |
| 1-4 ACKNOWLEDGEMENTS..... | 2 |
| CHAPTER 2 GENERAL REQUIREMENTS..... | 3 |
| 2-1 LABORATORY COMPLIANCE..... | 3 |
| 2-1.1 Introduction. | 3 |
| 2-1.2 Accrediting Agencies. | 3 |
| 2-1.3 USACE Validation. | 5 |
| 2-1.4 Compliance Checklist..... | 5 |
| 2-2 SUBMITTALS..... | 5 |
| 2-2.1 Introduction. | 5 |
| 2-2.2 Procedures. | 5 |
| CHAPTER 3 HOT MIX ASPHALT | 7 |
| 3-1 SUBMITTALS..... | 7 |
| 3-1.1 Introduction. | 7 |
| 3-1.2 Procedures. | 7 |
| 3-1.3 Requirements. | 7 |
| 3-2 MATERIALS AND MIX DESIGN | 9 |
| 3-2.1 Introduction. | 9 |
| 3-2.2 Aggregates..... | 10 |
| 3-2.3 Asphalt Binder..... | 14 |
| 3-2.4 Mix Design..... | 16 |
| 3-2.5 Mix Design Checklist..... | 22 |
| 3-3 PLANT PRODUCTION..... | 22 |
| 3-3.1 Introduction. | 22 |
| 3-3.2 Stockpile Operations..... | 23 |
| 3-3.3 Stockpile Checklist..... | 25 |
| 3-3.4 Hot Mix Asphalt Plants. | 26 |
| 3-3.5 Asphalt Plant Checklist..... | 29 |
| 3-4 TRANSPORTATION..... | 29 |
| 3-4.1 Trucking Checklist..... | 32 |

| | |
|------------------------------------------------|----|
| 3-5 SURFACE PREPARATION..... | 32 |
| 3-5.1 Introduction. | 32 |
| 3-5.2 Milling and Grinding. | 33 |
| 3-5.3 Crack Sealing..... | 36 |
| 3-5.4 Repair of Local Damaged Areas. | 39 |
| 3-5.5 Application of Tack Coat. | 39 |
| 3-5.6 Application of Prime Coat..... | 43 |
| 3-5.7 Surface Preparation Checklist. | 44 |
| 3-6 PLACEMENT. | 44 |
| 3-6.1 Introduction. | 44 |
| 3-6.2 Transfer from Truck to Paver. | 45 |
| 3-6.3 Laydown Operation. | 49 |
| 3-6.4 HMA Placement Checklist..... | 58 |
| 3-7 COMPACTION..... | 58 |
| 3-7.1 Introduction. | 58 |
| 3-7.2 Compaction Equipment and Procedures..... | 59 |
| 3-7.3 Transverse Joints. | 63 |
| 3-7.4 Longitudinal Joints. | 64 |
| 3-7.5 Density Measurement..... | 64 |
| 3-7.6 Factors that affect compaction..... | 65 |
| 3-7.7 Compaction Checklist. | 67 |
| 3-8 QC/QA TESTING AND ANALYSIS..... | 67 |
| 3-8.1 Introduction. | 67 |
| 3-8.2 Quality Control..... | 68 |
| 3-8.3 Control Charts..... | 69 |
| 3-8.4 Aggregate Gradation..... | 70 |
| 3-8.5 Asphalt Content. | 71 |
| 3-8.6 Air Voids. | 72 |
| 3-8.7 Voids in Mineral Aggregate..... | 72 |
| 3-8.8 Marshall Stability and Flow. | 73 |
| 3-8.9 In-place Density (Mat)..... | 73 |
| 3-8.10 In-place Density (Joint). | 74 |
| 3-8.11 Smoothness..... | 74 |
| 3-8.12 Grade. | 75 |

| | |
|---------------------------------------------|-----|
| 3-8.13 QC/QA Checklist..... | 76 |
| 3-9 PERFORMANCE PROBLEMS. | 76 |
| 3-9.1 Introduction. | 77 |
| 3-9.2 Rutting. | 77 |
| 3-9.3 Bleeding..... | 79 |
| 3-9.4 Surface distortion..... | 80 |
| 3-9.5 Cracking..... | 81 |
| 3-9.6 Raveling..... | 85 |
| 3-9.7 Moisture Damage. | 85 |
| 3-9.8 Block Cracking. | 86 |
| 3-9.9 Bibliography. | 87 |
| CHAPTER 4 PORTLAND CEMENT CONCRETE | 88 |
| 4-1 SUBMITTALS. | 88 |
| 4-1.1 Requirements. | 88 |
| 4-2 LABORATORY COMPLIANCE..... | 89 |
| 4-2.1 Accreditation and Certification | 89 |
| 4-2.2 USACE Validation. | 91 |
| 4-2.3 Compliance Checklist..... | 91 |
| 4-3 MATERIALS. | 91 |
| 4-3.1 Introduction. | 91 |
| 4-3.2 Cementitious Materials..... | 91 |
| 4-3.3 Aggregates. | 94 |
| 4-3.4 Chemical Admixtures..... | 97 |
| 4-3.5 Water. | 98 |
| 4-3.6 Other Materials..... | 99 |
| 4-3.7 Compliance Checklist..... | 99 |
| 4-4. MIX PROPORTIONING. | 101 |
| 4-4.1 Introduction. | 101 |
| 4-4.2 Design Criteria..... | 101 |
| 4-4.3 Aggregate Blending..... | 101 |
| 4-4.4 Trial Batches..... | 103 |
| 4-4.5 Compliance Checklist..... | 109 |
| 4-5 PLANT PRODUCTION AND CALIBRATION..... | 109 |
| 4-5.1 Introduction. | 109 |
| 4-5.2 Batch Plant Components. | 109 |

| | | |
|--------|--------------------------------------------------|-----|
| 4-5.3 | Uniformity Test. | 113 |
| 4-5.4 | Compliance Checklist..... | 117 |
| 4-6 | TRUCK MIXERS..... | 118 |
| 4-6.1 | Introduction. | 118 |
| 4-6.2 | Transit Truck Mixers..... | 118 |
| 4-6.3 | Transit Mixer Modes. | 119 |
| 4-6.4 | Truck Mixer Components..... | 119 |
| 4-6.5 | Uniformity Test. | 124 |
| 4-6.6 | Volumetric Mixers..... | 124 |
| 4-6.7 | Compliance Checklist..... | 126 |
| 4-7 | SURFACE PREPARATION AND DEMOLITION..... | 127 |
| 4-7.1 | Surface Preparation..... | 127 |
| 4-7.2 | Checklist for Surface Preparation..... | 128 |
| 4-7.3 | Demolition. | 128 |
| 4-7.4 | Checklist for Demolition. | 136 |
| 4-8 | PLACEMENT OF REINFORCEMENT/ LOAD-TRANSFER: | 136 |
| 4-8.1 | Introduction. | 136 |
| 4-8.2 | Slipform Construction. | 138 |
| 4-8.3 | Reinforcement Checklist. | 140 |
| 4-8.4 | Placement of Dowels..... | 140 |
| 4-8.5 | Dowel Checklist | 143 |
| 4-8.6 | Dowel Spacing..... | 143 |
| 4-8.7 | Dowel Placement Checklist..... | 145 |
| 4-8.8 | Dowelled Contraction Joints. | 145 |
| 4-8.9 | Contraction Joint Dowel Checklist..... | 148 |
| 4-8.10 | Doweled Construction Joints..... | 148 |
| 4-8.11 | Dowels in Construction Joint Checklist. | 157 |
| 4-8.12 | Alignment of Dowels..... | 157 |
| 4-8.13 | Dowel Alignment Checklist. | 159 |
| 4-8.14 | Placement of Tie Bars..... | 159 |
| 4-8.15 | Tiebar Checklist..... | 160 |
| 4-9 | TRANSPORTING CONCRETE..... | 160 |
| 4-9.1 | Introduction. | 160 |
| 4-9.2 | Haul Distance. | 161 |

| | |
|---------------------------------------------------|-----|
| 4-9.3 Equipment..... | 161 |
| 4-9.4 Transportation Checklist..... | 162 |
| 4-10 DISTRIBUTION AND PLACEMENT OF CONCRETE. | 162 |
| 4-10.1 Introduction. | 162 |
| 4-10.2 Placement and Distribution Checklist. | 167 |
| 4-11 SLIPFORM PAVING..... | 167 |
| 4-11.1 Introduction. | 167 |
| 4-11.2 Equipment..... | 167 |
| 4-11.3 Execution..... | 168 |
| 4-11.4 Common Problems. | 171 |
| 4-11.5 Compliance Checklist..... | 177 |
| 4-12 FIXED FORM PAVING. | 177 |
| 4-12.1 Introduction. | 177 |
| 4-12.2 Form Requirements. | 177 |
| 4-12.3 Paver Types. | 179 |
| 4-12.4 Accessories. | 181 |
| 4-12.5 Execution..... | 181 |
| 4-12.6 Common Problems. | 183 |
| 4-12.7 Compliance Checklist..... | 185 |
| 4-13 CONSOLIDATION..... | 185 |
| 4-13.1 Introduction. | 185 |
| 4-13.2 Vibrators. | 186 |
| 4-13.3 Execution..... | 188 |
| 4-13.4 Common Problems. | 189 |
| 4-13.5 Compliance Checklist..... | 191 |
| 4-14 FINISHING, TEXTURING AND EDGING. | 191 |
| 4-14.1 Introduction. | 191 |
| 4-14.2 Finishing..... | 191 |
| 4-14.3 Texturing | 195 |
| 4-14.4 Edging..... | 198 |
| 4-14.5 Common Problems | 199 |
| 4-14.6 Compliance Checklist..... | 200 |
| 4-15 CURING AND PAVEMENT PROTECTION..... | 200 |
| 4-15.1 Introduction. | 200 |

| | |
|--------------------------------------------------|-----|
| 4-15.2 Curing..... | 201 |
| 4-15.3 Checklist for Curing..... | 205 |
| 4-15.4 Protection..... | 205 |
| 4-15.5 Protection Checklist..... | 208 |
| 4-15.6 Hot Weather Protection..... | 208 |
| 4-15.7 Checklist for Hot Weather Concrete..... | 210 |
| 4-15.8 Cold Weather Protection..... | 210 |
| 4-15.9 Checklist for Cold Weather Placement..... | 212 |
| 4-16 GRADE AND SMOOTHNESS..... | 212 |
| 4-16.1 Introduction..... | 212 |
| 4-16.2 Grade..... | 212 |
| 4-16.3 Smoothness..... | 213 |
| 4-16.4 Diamond Grinding..... | 217 |
| 4-16.5 Compliance Checklist..... | 219 |
| 4-17 CONSTRUCTION AND CONTRACTION JOINTS..... | 219 |
| 4-17.1 Introduction..... | 219 |
| 4-17.2 Construction Joints..... | 220 |
| 4-17.3 Joint Plans..... | 221 |
| 4-17.4 Joint Alignment..... | 222 |
| 4-17.5 Partial Panels..... | 222 |
| 4-17.6 Drainage Structures and Embedments..... | 224 |
| 4-17.7 Joint Check List..... | 227 |
| 4-18 JOINT SAWING AND SEALING..... | 227 |
| 4-18.1 Introduction..... | 227 |
| 4-18.2 Saw Cut - Joint Layout..... | 227 |
| 4-18.3 Timing for Sawing..... | 228 |
| 4-18.4 Depth of Sawcut..... | 231 |
| 4-18.5 Sawing Equipment..... | 231 |
| 4-18.6 Temporary Sealing and Curing..... | 231 |
| 4-18.7 Random Cracking..... | 233 |
| 4-18.8 Factors Affecting Timing of Sawing..... | 235 |
| 4-18.9 Check List for Sawing..... | 235 |
| 4-18.10 Joint Reservoir Sawing..... | 235 |
| 4-18.11 Preparation for Sealant..... | 237 |

| | |
|----------------------------------------------------------------|-----|
| 4-18.12 Checklist for Joint Reservoir Sawing and Sealing. | 240 |
| 4-19 QC/QA TESTING AND PAY ADJUSTMENTS. | 241 |
| 4-19.1 Introduction. | 241 |
| 4-19.2 Contractor Quality Control (CQC). | 241 |
| 4-19.3 Quality Assurance (QA) and Pay Adjustment. | 244 |
| 4-19.4 Compliance Checklist. | 252 |
| 4-20 IDENTIFICATION AND CAUSE OF HARDENED PCC DISTRESS. | 252 |
| 4-20.1 Introduction. | 252 |
| 4-20.2 Plastic Shrinkage Cracks. | 252 |
| 4-20.3 Spalling. | 254 |
| 4-20.4 Weak Surfaces. | 257 |
| 4-20.5 Slab Removal and Replacement. | 257 |
| 4-20.6 Compliance Checklist. | 259 |

CHAPTER 1 INTRODUCTION

1-1 OVERVIEW.

This Pavement Inspection Manual is written to provide supplemental information, and help provide specific training for pavement construction inspectors. It primarily addresses Department of Defense airfields but also applies to hot mix asphalt and Portland cement concrete pavement construction on non-airfield areas such as roads. This manual provides guidance on all aspects of pavement construction and provides supplementary information to the other referenced technical publications. It is not intended to take the place of the contract specifications but should be used along with specifications to help ensure that a high quality pavement is constructed.

Airfield pavements are constructed by the same contractors that construct roads and highways. The airfield pavements often require higher quality materials than highways and it is important to ensure that the contractor produces a mix that meets the airfield specification requirements. Since most of the work performed by most contractors is on highways they may not be familiar with the UFGS specification requirements and this will require close inspection at the start-up of work. Airfield pavements are unique. In comparison to highways they are exposed to higher tire pressures, higher wheel loads, and blast and heat from jet engines. Any spalling, raveling, or other deterioration can lead to particles of pavement becoming dislodged resulting in foreign object debris (FOD). This FOD can become ingested into a jet engine resulting in costly damage and potentially loss of life.

The objective in constructing any pavement is to satisfy the design criteria and provide quality for maximum serviceable life with minimum maintenance. This objective may be achieved only through detailed attention to each step in the construction of a pavement. Inspectors play a key role in obtaining pavement quality and without their full commitment to the project, performance is likely compromised. They have to read and understand the contract specifications, observe and evaluate the contractors work, and take appropriate action on any contractor deficiencies. This includes the review of initial submittals through participation in the final acceptance. It involves the quality of materials and construction as well as workmanship.

The control of the quality and the production is the responsibility of the contractor and the assurance of the quality is the responsibility of the inspector and owner. Many times one inspector is burdened with the responsibility for multiple contracts, which may be under construction at the same time. Sufficient qualified and experienced inspectors have to be provided to insure quality. Inspectors have to be thoroughly familiar with all provisions of the contract documents, including submittals. They have a difficult role because they are sometimes put into the position of justifying contract requirements, especially when they affect

schedules and unanticipated contractor costs. This manual should provide the inspectors with the background for many of the specification requirements and help ensure improved performance and a more satisfied customer.

1-2 PURPOSE.

The purpose of this manual is to provide guidance to the inspector, Quality Assurance (QA), and Quality Control (QC) representatives on construction oversight of hot mix asphalt (HMA) and Portland cement concrete (PCC) airfield pavements. This manual is not a contract document and does not take the place of the project specifications but is to be used as a companion document. The manual identifies a number of areas where problems often occur and it helps to clarify some of the specification requirements that may be a little more difficult to understand.

1-3 FORMAT.

The format of this manual follows the anticipated sequence of construction activity: materials and mix design, mix production, transporting mix, placing mix, QC/QA, and discussion of potential performance problems. A separate chapter is devoted to concrete and asphalt with each chapter being divided into each of these specific topic areas. Inspector's checklist items are provided in colored text boxes. More detail concerning the checklist items is provided in the body of each chapter. Notes and "rules of thumb" are provided in yellow text boxes and inspector's checklist items are provided in green text boxes.

The specification requirements are addressed in UFGS 321311, "Concrete Pavement for Airfields and Other Heavy-Duty Pavements More Than 10,000 Cubic Yards" and in UFGS 321215, "Hot Mix Asphalt for Airfields."

1-4 ACKNOWLEDGEMENTS.

This manual is based on the "PCC Airfield Pavement Workshop" presentation developed by the U.S. Army Engineers, Transportation Systems Mandatory Center of Expertise (TSC) and the "HMA Airfield Pavement Workshop" presentation developed by the U. S. Army Engineer Research and Development Center (ERDC). Thanks to Terry Sherman and Gene Gutierrez for the use of their PCC photographs and for their guidance and insight and to Ray Brown for the use of his HMA photos. Thanks also to Richard Donovan and Jack Scott for their photos and authoring portions of this document.

CHAPTER 2 GENERAL REQUIREMENTS

2-1 LABORATORY COMPLIANCE.

2-1.1 Introduction.

Contractor Quality Control (CQC) and Government Quality Assurance (GQA) begin with assuring that commercial or contractor-operated laboratories and staff are qualified to provide test results in accordance with the standards referenced in the specifications. For concrete and concrete aggregate testing and evaluation, laboratory compliance with ASTM C 1077, "Standard Practice for Laboratories Testing Concrete and Concrete Aggregates for Use in Construction and Criteria for Laboratory Evaluation" is required. For hot mix asphalt materials and mixtures compliance with ASTM D 3666, "Minimum Requirements for Agencies Testing and Inspecting Bituminous Paving Materials" is required.

2-1.2 Accrediting Agencies.

Independent third-party agencies provide the basic laboratory and staff inspection services. These inspections are broadened into a laboratory accreditation by including a review of the laboratory's organization, human resources, facilities, equipment, reports and records, and quality control system.

Independent third-party accrediting agencies include:

- NVLAP, National Institute of Standards and Technology (<http://ts.nist.gov/standards/accreditation/index.cfm>)
- A2LA, American Association for Laboratory Accreditation (<http://www.a2la.org/>)
- CMEC, Construction Materials Engineering Council (<http://www.cmec.org/>)
- AASHTO, American Association of State Highway and Transportation Officials (<http://www.amrl.net/Portal/AMRLLogin.aspx>)
- ERDC-MTC, U.S. Army Engineers Research and Development Center, Materials Testing Center (<http://www.wes.army.mil/SL/MTC/mtc.htm>)

Upon accreditation by any of these agencies, the laboratory is issued a certificate which lists the laboratory's name and address and the individual ASTM or AASHTO methods for which the laboratory is accredited.

This information can be double-checked by reviewing the accredited laboratories category on the accrediting agency's website. An example of a print out from the ERDC MTC website is presented in Figure 2.1.

NOTE: The accreditation is for the listed laboratory only and does not cover branch offices, field laboratories, portable laboratories, or other locations. Separate inspections are required for these subsidiaries.

Not all the specified tests may be listed for a given laboratory. Typical omissions include ASTM C 78, C 1260 and C 1567. Additional inspections or an additional accredited laboratory will be required to perform any missing test methods.

Figure 2.1 Validation Printout from ERDC-MTC Website

| | |
|---------------------------------------------------------------------------------------------------------------------------------------------------|--------------------------|
| Laboratory Name | Street Address |
| City, State, Zip Code Telephone Number | |
| Expiration Date: January 27, 2009 | |
| Aggregate: ASTM C40 C117 C127 C128 C136 C29 C88 C123 C131 C142 C535 C566 C702 C1252 C1260 D75 D2419 D4791 D5821 CRD-C104 CRD-C119 CRD-C130 | |
| Bituminous: ASTM D70 D2170 D2171 D2726 D3203 D3666 D4867 D5444 D6307 D6925 D6926 D6927 | |
| Concrete: ASTM C31 C39 C138 C143 C172 C173 C231 C1064 C42 C78 C157 C174 C192 C511 C617 C1077 C1231 | |
| Soils: ASTM D421 D422 D698 D1140 D1557 D2166 D2216 D2434 D2435 D2487 D2488 D2922 D3017 D3740 D4253 D4254 D4318 D4643 D5084 | |
| Masonry: ASTM C140 C1093 | |
| AASHTO Accredited | Methods Inspected |

Concrete technicians are certified by local chapters of the American Concrete Institute (ACI) located at http://www.concrete.org/certification/cert_prog.asp. The following grades of technician certification are required:

- Concrete Transportation Inspector - personnel responsible for inspection of concrete paving operations
- Concrete Flatwork Technician/Finisher - lead foreman or journeyman of the concrete placing, finishing and curing crews
- Concrete Field Testing Technician, Grade I - field testing technicians
- Concrete Strength Testing Technician or Laboratory Testing Technician, Grade I or II - laboratory testing technicians.

There is no national certification program for those involved with hot mix asphalt testing and inspection. Within DOTs, individuals are certified at the state or regional level in some regions. Certification categories generally include three areas: materials technician, mix designer, and roadway inspector. Those

working on airfield pavements should, as a minimum, be certified within the local state DOT. A national certification program, is needed but has not yet been established.

2-1.3 USACE Validation.

For projects managed by the U.S. Army Corps of Engineers (USACE), validation of the laboratory is required. This validation is performed by ERDC-MTC. The validation process ranges from a desk audit of the accrediting agency's documentation for an accredited laboratory to a full scope inspection/accreditation for an unaccredited laboratory. This validation is performed at the Contractor's expense and should be performed prior to initiating any asphalt or concrete materials sampling or testing.

2-1.4 Compliance Checklist.

- Submittal includes:
 - Laboratory accreditation certificate
 - ACI concrete technician certificates
 - Local DOT certification for those dealing with HMA
- The accredited laboratory actually does the work, it's not subcontracted out
- Accreditation should not expire for the duration of the laboratory work
- All the specified test methods have been inspected
- ERDC-MTC validation has been conducted (for USACE managed projects)
- All certifications are current and the appropriate level of expertise
- Use the agency websites to check and resolve discrepancies

2-2 SUBMITTALS.

2-2.1 Introduction.

The submittal process is the Contractor's method for documenting his materials, methods, and quality control processes to produce concrete pavement in accordance with the specification requirements.

All submittals for a definable feature of work shall be submitted and approved before the preparatory meeting is scheduled for that feature. The Contracting Officer may request submittals in addition to those specified when deemed necessary to adequately describe the work covered in the respective sections.

2-2.2 Procedures.

The contact submittal procedures are contained in UFGS 013300, "Submittal Procedures." The following items highlight the requirements.

2-2.2.1 Contractor Submittals:

- Units of weights and measures used on all submittals are to be the same as those used in the contract drawings.
- Each submittal is to be complete and in sufficient detail to allow ready determination of compliance with contract requirements.
- Contractor's Quality Control (CQC) System Manager and the Designer of Record, if applicable, to check and approve all items prior to submittal and stamp, sign, and date indicating action taken.
- Proposed deviations from the contract requirements are to be clearly identified.
- Submittals requiring Government approval are to be scheduled and made prior to the acquisition of the material or equipment covered in the submittal.

2-2.2.2 Government Review:

Government approval is required for submittals with a "G" designation; submittals not having a "G" designation are for information only. Government approval is required for extensions of design, critical materials, deviations, equipment whose compatibility with the entire system must be checked, and other items as designated by the Contracting Officer.

CHAPTER 3 HOT MIX ASPHALT

3-1 SUBMITTALS.

3-1.1 Introduction.

The submittal process is the Contractor's method for documenting materials, mix design, equipment, construction methods, and quality control processes to produce hot mix asphalt in accordance with the specification requirements. All submittals for a definable feature of work shall be submitted and approved before the preparatory meeting is scheduled for that feature. The Contracting Officer may request submittals in addition to those specified when deemed necessary to adequately describe the work covered in the respective sections.

3-1.2 Procedures.

The contact submittal procedures are contained in UFGS 01 33 00, "Submittal Procedures." The following items highlight the requirements, as applicable to hot mix asphalt (HMA) airfield pavement construction.

3-1.2.1 Contractor Submittals. Units of weights and measures used on all submittals are to be the same as those used in the contract drawings. Each submittal is to be complete and in sufficient detail to allow ready determination of compliance with contract requirements. Contractor's Quality Control (CQC) System Manager and the Designer of Record, if applicable, are to check and approve all items prior to submittal and stamp, sign, and date indicating action taken. Proposed deviations from the contract requirements are to be clearly identified. Submittals requiring Government approval are to be scheduled and made prior to the acquisition of the material or equipment covered in the submittal.

Government approval is required for submittals with a "G" designation; submittals not having a "G" designation are for information only. Government approval is required for extensions of design, critical materials, deviations, equipment whose compatibility with the entire system must be checked, and other items as designated by the Contracting Officer. All submittals in the project specifications are classified as "G."

3-1.3 Requirements.

The submittal requirements are provided in the project specifications. Some of the more important items to look for are discussed below.

3-1.3.1 Placement Plan. The contractor is required by the specifications to provide a placement plan. This placement plan should provide information including proposed schedule of work, planned lane width, sequence of paving,

and method for handling longitudinal joints. When changes in the plan are expected a revised plan should be submitted to the government.

3-1.3.2 Mix Design. The items required to be provided in the mix design are clearly identified in the specifications. Some important items that are often overlooked in the mix design include identifying the amount of natural sand used in the mixture, the laboratory compactive effort during mix design, and the grade of asphalt cement.

Mix designs that were developed several months or in some cases several years prior to the project are sometimes submitted for approval. Aggregate sources and asphalt cements may change with time so an old mix design may not still be accurate. Hence, the specifications require that the mix design shall not be over 6 months old and this requirement should be enforced. If an old mix design is desired for use, the contractor must verify that it is still accurate.

3-1.3.3 Contractor Quality Control Plan. The CQC program does not automatically ensure that satisfactory construction quality is obtained. QA has to make sure that CQC takes the initiative to identify any material or construction issues and to take steps to correct the problems. In many cases the CQC will only be as strict on the contractor as QA requires, hence, if QA does not closely oversee CQC then CQC will not closely control the contractor.

The first step to ensuring that the CQC program is effective is the development of an acceptable QC plan. The QC plan should clearly lay out the steps that QC is going to take to ensure that a quality product is produced. The plan should provide detail on types of inspections to be made, tests to be conducted, where samples will be taken, number of tests to be conducted, and proposed action to be taken if inspections or test results are not satisfactory.

3-1.3.4 Submit Samples of Aggregates and Asphalt Cement. The primary purpose of these samples is to allow the QA to validate the mix design if desired. Most of the time the mix design can be evaluated based on the information provided but there might be cases where one or more of the tests may need to be verified. The aggregates should be inspected to determine if natural sand is being used and to observe the overall quality of all aggregate.

Look for good angularity in the aggregate and make sure that there is no contamination such as clay balls and organics. Angularity is typically a potential problem with naturally occurring gravels and sands (however the amount of sand to be used in the mix is controlled so rounded natural sand is allowed). Naturally occurring gravels must be properly crushed to be acceptable for HMA. If there are any concerns about the mix design, the mix design should be validated by QA or, if necessary, the contractor should provide additional test results and/or explanations concerning the design.

3-1.3.5 QC Test Results. The contractor must provide a QC plan to indicate the testing and inspection plan and this has to be approved by the government. As the tests are conducted and inspections are made during the construction process, a report of the results should be prepared and provided to the government for review and concurrence. These test results and inspection observations should be made available to the government within a short period of time after the work is completed. The contractor should indicate in the CQC plan when the reports will be made available to the government. Generally test and inspection results are made available to the government by the end of the day following the day that work was completed (24 hours).

3-1.3.6 Asphalt Cement Certification. The contractor should provide the government with a certificate, for each truckload of asphalt cement, from the material supplier showing the asphalt cement test results and showing that the asphalt cement being used meets the specification requirements. A certificate should be provided for the original asphalt cement used in the mix design and for all additional asphalt cement delivered to the contractor. The government does not normally conduct these tests as part of QA but, if needed, samples can be taken and sent to a commercial laboratory for testing.

Also it is good to keep samples of the asphalt cement in a closed container so that the asphalt cement can be tested later if a problem occurs. It is recommended that these samples be kept for at least one year after the entire project is completed.

3-1.3.7 Laboratory Certification. When working on a military airfield project, the laboratory (QC and/or QA) to be used on the project must be inspected and validated by the Materials Testing Center of the Engineer Research and Development Center, Corps of Engineers before work begins. This certification will take a little time so QC and QA, if applicable, should contact the Center early to allow enough time to certify the laboratory before work begins.

3-2 MATERIALS AND MIX DESIGN

3-2.1 Introduction.

The quality of the materials used to produce an asphalt mixture is very important to ensure good performance of the constructed product. Without high quality materials, the performance of the project will likely not be satisfactory even if good mix design and construction methods are used. After it has been determined that acceptable materials are available, a mix design is developed to determine the optimum asphalt cement and aggregate proportions. Generally the mix is designed by selecting the proportions of aggregates to provide a gradation meeting the specification requirements and then determining the asphalt content to provide 4% air voids in the mixture.

Even though the mix design is typically performed by the contractor, it is important that QA ensure that the completed design is acceptable prior to beginning construction of the project. It is also important that the design, as specified in the specifications, be a recent design since materials, such as aggregates and asphalt binder, change with time. A design that was conducted 2 or 3 years ago may not be representative of the materials currently available.

A government representative should ensure that the materials and mix design meet the specification requirements. This will involve reviewing the finished design and may involve observing some of the lab testing during conduct of the design.

The overall management of the construction project is the responsibility of the government and this requires that proactive steps be taken to ensure that the overall quality is satisfactory. It is not good enough to simply rely on CQD to ensure that the construction quality is acceptable. This is a recipe for disaster.

The information provided in this section provides guidance to the inspector that should enhance his/her ability to evaluate the quality of materials and mix design. This discussion will include aggregates, asphalt cement, and mix design.

3-2.2 Aggregates.

Prior to testing the aggregates, representative samples of each aggregate source to be used must be taken. There are two types of samples that can be obtained: representative and random. A representative sample is taken in such a way that the sample is representative of the entire stockpile of material being evaluated. A random sample is taken by obtaining a sample in a random location or at a random point in time. This random sample will likely not be representative of the entire quantity of material being sampled but it should represent the material in the localized area where the sample is taken.

Taking a number of random samples and then combining them will provide a representative sample of the material being evaluated. Representative samples are generally taken for materials evaluation and mixture design prior to start of mixture production. Random samples are typically utilized during quality control operations during the construction process. For example, a sample of asphalt mixture for gradation testing is normally taken at a random point in time during the production of the mixture.

It is important that QA observe the condition of the stockpiles that are going to be used on the project. QA has to be at least knowledgeable enough about the construction operation to ask questions of the QC people that will help assure that sufficient control measures are in place to provide a quality product at the conclusion of the project. A good time to observe the stockpiling operation is when aggregate samples (ASTM D75) are being taken for mix design.

It is important to look at stockpiling methods to ensure that excessive segregation is not occurring. It is also important to look at the stockpiles to ensure that they don't contain any organic materials, clay balls, or any other type of contamination which may affect the quality of the stockpiles. Visually inspecting aggregate samples in the laboratory or in the office does not provide a good evaluation of the overall quality of the aggregate. Visually inspecting the stockpiles does provide a good picture of the quality as far as clay balls, organic material, etc. This will be discussed in more detail in the section on asphalt plants.

In areas where natural gravels are used it is important to ensure that the gravel is properly crushed before use in asphalt mixtures (Figure 3-1). Rounded particles do not provide sufficient shear strength and often result in the mixture rutting when exposed to traffic. The fractured face count, which is specified in the specifications, is used to determine if a coarse aggregate is properly crushed. Figure 3-1 shows crushed gravel on the left side and rounded, uncrushed, gravel on the right side.

It is also important to ensure that too much natural sand is not used in the mix. For airfields the amount of natural sand is limited to 15 percent maximum according to the specifications. Natural sands tend to be rounded which can result in a mixture stability problem. Also the asphalt often does not bond very well to sand particles primarily due to the smooth sides and/or high silica content resulting in eventual stripping within the mixture as well as other performance problems.

Figure 3-1 Rounded Gravel on the Right and Crushed Gravel on the Left



After the aggregate samples are obtained, the materials are brought back to the laboratory for testing. The specifications identify the tests that have to be

conducted and provide the requirements that the aggregates must meet. If in doubt about the quality of the material being proposed for use, past performance is often a very good indicator. Since the state Departments of Transportation (DOTs) do a lot of HMA work and are typically very familiar with specific aggregates throughout their state, they should be contacted if in doubt about the aggregate quality or the history of performance for a particular aggregate type. They will likely have a good understanding of the history of past performance with each aggregate available within the state.

The inspector cannot oversee all of the sampling and testing involved with the mix design but enough oversight needs to occur to provide some level of understanding of what materials are being used and the overall quality of these materials. The best way to obtain some indication of the quality of the materials and the way the materials are being handled is to visit the plant where the materials will be produced.

It is difficult to obtain truly representative samples from stockpiles of aggregate. The easiest place to take a sample is near the bottom of the stockpile but this usually contains a coarser gradation since the coarse material tends to roll down the side of a stockpile when stockpiles are being built or material is being added to a stockpile.

A typical stockpile is shown in Figure 3-2. When taking a representative sample (ASTM D75) of the stockpile, several small random samples should be taken at various points around the stockpile but about $\frac{1}{2}$ of the way up the side of the stockpile. It is also important that the surface material be removed when taking a sample of a stockpile and the material sampled is taken from underneath the outer material that is removed.

Some stockpiles are significantly high so one must be careful when working around a stockpile, otherwise, an injury may occur due to the side of the stockpile giving way. If the stockpile is too high it may be necessary to remove samples with a loader or some other device to ensure safety to those involved in taking the samples. A representative sample can then be taken from the bucket load of material taken from a random location.

When utilizing a loader to retrieve samples, it is recommended that the bucket be at least six inches above the bottom of the pile to avoid both contaminants and coarser particles. It is good practice to have the loader go through the face of the material and then turn the sample over on the ground. Once the sample is on the ground, the top should be scalped to sample from the “heart” of the material.

Some of the laboratories conducting QC testing for the contractor are not very well qualified and some oversight is needed to ensure that proper sampling and testing techniques are used. When the contractor and QC know that there will be

oversight, they will generally make an effort to ensure that qualified people perform the work and that all appropriate test procedures are followed. The lack of good oversight only encourages some laboratories to use some of their less experienced people on the project often resulting in loss in test quality and lack of good inspection of the constructed product.

The problems that are most commonly observed with aggregate properties, tests, and inspections include:

- Too much material passing the No. 200 sieve,
- Inadequately crushed coarse aggregate (this only occurs with naturally occurring gravel aggregates),
- Too much natural sand, and
- contamination with clay balls and organics

Figure 3-2 Typical Aggregate Stockpile



The high amount of material passing the No. 200 sieve typically occurs with crushed stone. Some crushed stone is softer than others and it is this softer stone that generates high dust content during the crushing operation. There are a number of ways this high percentage of No. 200 material can be reduced. It can sometimes be reduced by adjusting the percentages of each stockpile being used, wasting some of the dust caught in the dust collector, washing the fine aggregate stockpile, or obtaining a new source of aggregate.

Inadequately crushed coarse aggregate may occur when gravel materials are used but should not be a problem when crushed stone is used. When the gravel does not meet the fractured face requirements, this is caused by inadequate set

up at the crushing operation. In general to produce crushed gravel with up to ½ inch maximum aggregate size requires that the minus ½ inch material must be removed from the uncrushed gravel stockpile before crushing. So if the quarry does not first waste this material, adequately crushed material will not be produced.

Too much natural sand can occur anywhere that natural sand is available. It is typically cheaper than other aggregate materials so using the sand can result in somewhat lower material costs. Some amount of natural sand is not detrimental to the mixture quality but it must be ensured that the amount used does not exceed the specification requirements of fifteen percent. Once the sand is mixed with the other aggregates and asphalt, there is no way to determine the amount of natural sand in the mixture. The only way to measure the amount of natural sand in a mixture is to measure it from the rate of feed of the sand compared to other materials during mixture production.

There are lots of examples where stockpiles contain clayballs and organic material. The most likely source of these problems is the natural sand stockpile but it can occur in all aggregates. When a stockpile has organics or clayballs, it should not be allowed to be used in the HMA production. It is unlikely that this problem will be noticed when materials are sampled and submitted to the government for review. Generally, the only way to see this problem during the production process is to closely observe the aggregate stockpiles at the HMA plant.

Checklists for aggregates during mix design

- 1. Ensure that percentage passing the No. 200 sieve is not too high**
- 2. Ensure that aggregate is adequately crushed**
- 3. Make sure that the amount of natural sand used in the mixture does not exceed the specification limit**
- 4. Observe stockpiles, in addition to testing, to ensure that no organic material or clayballs are in stockpile**
- 5. All specification requirements for the aggregate should be met.**

3-2.3 Asphalt Binder.

The grade of asphalt binder to be used will be specified in the specifications. The testing, to confirm that the asphalt cement supplied to the project meets the specification requirements, is typically performed by the refinery and/or asphalt supplier and a certificate of tests is provided, with each tanker of material

delivered to the plant, showing the test results for the asphalt cement. Unless there is a potential problem or concern, additional testing of the binder is not typically performed by the government. Certainly if there is reason to believe that government testing should be performed then this should be accomplished but otherwise this is not normally performed.

The most common procedure that is used is to take 1 gallon samples of the asphalt binder during binder delivery and to store these samples for future testing if necessary. If there is no performance problem after a predetermined amount of time, typically 1 year after completion of construction, then the samples can be disposed.

The asphalt binder grading system that is normally used is the performance grading (PG) system. With this system the grade of asphalt binder is specified based on the upper and lower temperatures that are expected at the location the pavement is being constructed.

The most common grade is PG 64-22. This PG grade is designed to ensure that the asphalt binder is stiff enough to perform satisfactorily up to a high pavement temperature of 64 degrees Celsius (C) and flexible enough to perform satisfactorily down to a low pavement temperature of -22 degrees C. If the pavement is built in an area with a climate that experiences hotter temperatures then the high end grade of the asphalt binder will have to be increased above the 64 degrees C. If the pavement is built in a colder climate then the low end grade of the asphalt binder may have to be decreased below -22 degrees C.

The designer will often bump the grade of asphalt binder when paving taxiways, runways, etc. where there will be slow moving traffic. In other words the high temperature PG grade may be increased to a 76 from a 64, for example, to provide a factor of safety against rutting. This higher grade asphalt binder will likely be more expensive but it will be more resistant to rutting.

Adding the high temperature and low temperature numbers together will help determine if the asphalt binder is modified (polymer or some other modifier). If the sum of the high and low temperature numbers exceeds 90 then the asphalt binder is likely modified. If the sum is approximately 90 or less then the asphalt binder is likely not modified. For example, a PG 64-22 adds up to 86, hence, this asphalt binder is probably not modified. However, a PG 76-22 adds up to 98 and this asphalt binder is almost certainly modified. Generally a modified asphalt binder will cost significantly more than a non-modified asphalt binder.

It is not uncommon for a contractor to have more than one asphalt binder storage tank. These extra tanks are needed since many state DOTs typically use at least 2 grades of asphalt binder for a given climatic area. One grade is used for normal construction and another grade is used for high volume roads such as

interstate highways. It is important to ensure that the correct grade of asphalt binder is actually being added to the mixture being produced.

Even though the correct grade of asphalt binder is added to the mix during production, the grade can be altered by the amount of heat that is applied to the mixture. The specifications set an upper limit of approximately 350 degrees Fahrenheit (F) for the asphalt mixture. When the mix is heated to approximately 350 degrees F or higher, damage will likely occur to the asphalt binder. This high heat will remove some of the lighter portions of the asphalt binder and some oxidation will occur during the mixing process.

After the asphalt binder (which is in thin films coating aggregate particles) is exposed to high heat, it will stiffen and become more brittle and will have more cracking potential at low temperatures. Hence, care is needed during plant production to ensure that excessive damage to the asphalt binder does not occur. It is important that QC make temperature measurements throughout the day to ensure that mixture temperatures are maintained within a desirable range (high enough for the mix to be workable and compactable but low enough so that the asphalt cement is not damaged).

3-2.4 Mix Design.

After the asphalt binder and the aggregate have been shown to meet the specification requirements, a mix design can be performed. There is no need to begin the design before it is known that the asphalt binder and the aggregate are satisfactory. Retests on both the aggregates and liquid asphalts may be an option when either material fails to meet design requirements.

There are two methods that are generally used to design asphalt mixtures. The most common method for airfields is the Marshall method, however, the most common method for highways is the Superpave mix design method. The biggest difference between these two methods is the procedure used to compact samples in the laboratory. The Marshall method uses a hammer (Figure 3-3) while the Superpave method uses a gyratory compactor (Figure 3-4).

The first step in the mix design process is to perform aggregate gradation tests on all aggregates to be used and then to determine the percentage of each aggregate to use in the mixture to provide a blend of aggregates that meets the specification requirements. This is typically a trial and error procedure that can quickly determine the percentage of each aggregate. Washed gradations (ASTM C117) should always be used during the mix design process.

Figure 3-3 Manual Marshall Hammer



Figure 3-4 Superpave Gyrotory Compactor



After the desired percentage of each aggregate is determined, a number of samples are prepared using these percentages and placed in an oven to heat and dry the aggregate. Typically, after storing the samples overnight at the desired mixing temperature, various percentages of asphalt binder are added to the aggregate blends. Most often, three replicate samples will be prepared at each asphalt binder content and the samples compacted. The samples should be compacted with 75 blows per face with a Marshall hammer when designing mixtures for an airfield or with 75 gyrations with a gyratory compactor if Superpave is specified for design.

The Marshall hammer should be the manual type (Figure 3-3). Research has shown that the mechanical and manual hammers provide different results when used for compaction. Typically the mechanical hammer will provide a slightly lower density than the manual hammer. This lower density will require that more asphalt binder be added to the aggregate to provide the proper air void content after compaction. It is important that the compaction pedestal be placed on and anchored to a solid foundation prior to being used for compacting samples. Generally, a concrete slab is used as the foundation.

There have been many instances where the quality control personnel on a project used a mechanical hammer even though the manual hammer is specified in the specifications. A mechanical hammer can be used but it must first be calibrated to determine the number of blows needed to provide a density similar to that with the manual hammer. This calibration needs to be performed using the mixture being used for the project since the mixture properties will affect the correlation between the two hammers. When a mechanical hammer is used for compaction, a copy of the calibration should be provided to the government.

After the samples are compacted the mixture properties have to be determined. Properties that are used to evaluate the quality of asphalt mixture include:

- Unit weight
- Air voids
- Voids in mineral aggregate (VMA)
- Voids filled with asphalt
- Stability
- Flow

The mix design should show plots of the mixture properties versus asphalt content. Typical plots are shown in Figure 3-5. The design is usually conducted to provide 4 percent air voids in the laboratory compacted samples.

Figure 3-5 Plots of Mixture Properties

DENSITY VS. ASPHALT CONTENT

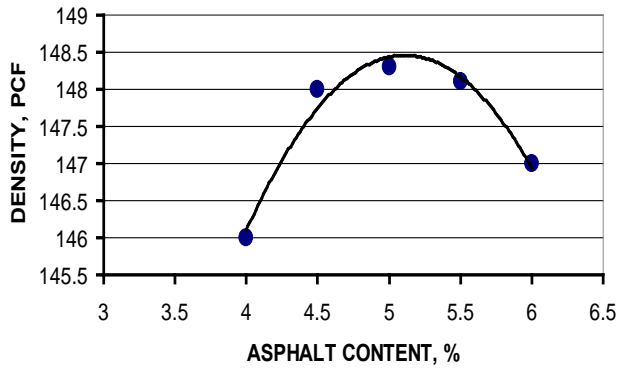

STABILITY VS. ASPHALT CONTENT

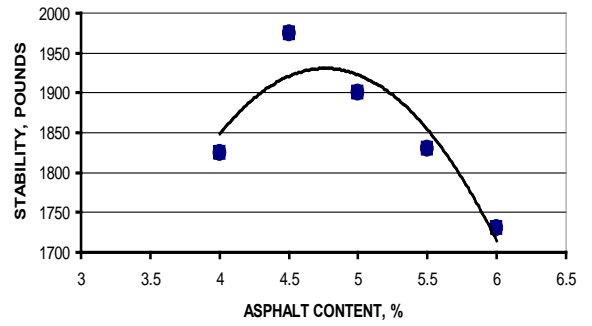

VOIDS VS. ASPHALT CONTENT

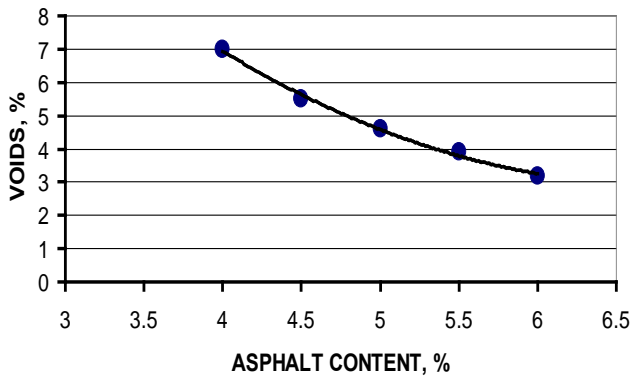

FLOW VS. ASPHALT CONTENT

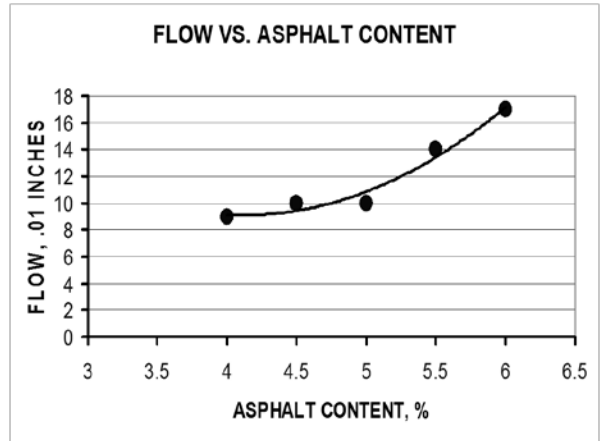

VMA VS. ASPHALT CONTENT

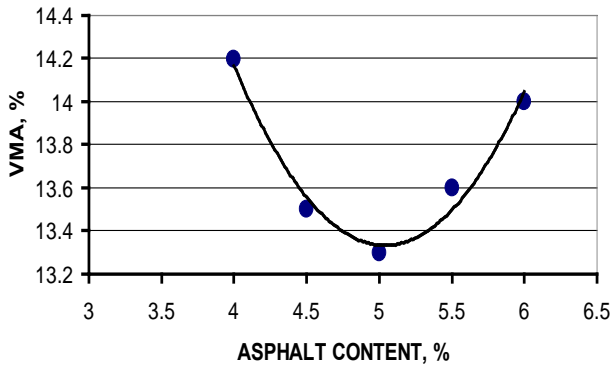

The mixture properties have typical relationships when plotted vs. asphalt content. There is always variability in measured mixture properties so the trend might not be obvious in some cases. As the asphalt content increases the density increases to a point and then begins to decrease. With some aggregates the density continues to increase slightly with increasing asphalt content within the range of asphalt contents normally used. This is not a problem.

As the asphalt content increases, the stability increases to a point and then begins to decrease with increasing asphalt content. The stability curve looks similar to the unit weight curve but generally it will peak at slightly lower asphalt content.

As the asphalt content increases, the air voids decrease. The rate of decrease reduces as the asphalt content continues to increase.

As the asphalt content increases, the flow value increases. The rate of increase is higher as the asphalt content continues to increase. The flow test results are sometimes unreasonably high when using modified binders. This is a problem with the test and does not indicate a mix that will perform poorly. For this reason, the flow requirements are generally waived when modified asphalts are used.

As the asphalt content increases, the VMA decreases to a point and then begins to increase again. Generally the bottom of the VMA plot is very near the optimum asphalt content. The VMA in the mix has to be above some minimum number so that a reasonable amount of asphalt binder can be added to the mixture.

The VMA is a measure of the voids in between the aggregate particles and if the VMA is too low then there is not sufficient room for the asphalt binder. The VMA is primarily controlled by the gradation and particle shape of the aggregate and is most sensitive to the percentage of material passing the No. 200 sieve. As this percent passing the No. 200 sieve increases, the VMA decreases.

After the mix design is completed tests are conducted to measure the moisture susceptibility of the mixture (ASTM D 4867). If the mixture is susceptible to moisture, the asphalt may strip off of the aggregate during the life of the pavement resulting in loss of asphalt binder from the mixture and thus loss of cohesion. This testing involves preparing samples to simulate the expected density in the field. One half of the samples will be conditioned in water and the other half will not be conditioned. If the conditioned samples lose too much tensile strength then the mixture fails the test and some adjustments must be made such as adding an anti-strip agent to the mixture.

Sufficient data must be provided to allow for a good evaluation of the mix design. The government representative should have a good understanding of all aspects

of mix design to be able to identify any deficiencies in the design. Some of the data that should be included in the mix design report are provided below:

- Aggregate properties
 - LA abrasion
 - Specific gravity and absorption
 - Flat and elongated count
 - Fractured face count
 - Fine aggregate angularity
 - Sand equivalency
 - Soundness
 - Gradation

- Percent passing each sieve size for each aggregate used and for the blended aggregate
- Percent of natural sand in the mixture
- Plot showing gradation and specification limits
- Optimum asphalt content
- Table showing volumetric and specific gravity properties of asphalt mixture
- Material proportions
- Grade of asphalt cement
- Compactive effort---number of blows per face with manual hammer or calibrated mechanical hammer. When using Superpave gyratory machine show number of gyrations
- Lab mixing and compaction temperature
- Plot of mix properties versus asphalt content
- Tensile strength ratio
- Properties of RAP if used
- Any additives such as anti-stripping agents, polymers, or warm mix products

It is not uncommon to have mix designs submitted that don't include all of the information needed. A mix design should not be accepted if all required information is not provided. In this case the mix design should be rejected and required to be resubmitted.

There are a number of issues that can cause the mix design to not be acceptable. The most common problems are: failure to calibrate the mechanical hammer to provide results equivalent to 75 blows with the manual hammer, not clearly identifying the natural sand, use of too much natural sand, or failure to meet the minimum VMA requirements. There are also often errors or omissions in the mix design that need to be identified and corrected before being accepted. The data and calculations for the volumetrics should be included in the mix design submission.

Once the mix design is completed, this provides a starting point for beginning construction. There are provisions in the specifications that allow the contractor to modify the mix design based on plant produced materials. The mix design will likely need to be adjusted once construction begins since the materials produced during construction will not be exactly the same as that used during mix design. Typically, the aggregates will break down some during plant production resulting in a finer mixture than that used for mix design. Hence, the percentage of materials used will have to be adjusted slightly to provide the same or similar gradation or the asphalt content will need to be adjusted so that the mixture will have an acceptable air void content. Normally, when a contractor performs a mix design, they understand that the aggregate breaks down during plant production so they use some of the baghouse fines in their mix design to account for the expected breakdown in the asphalt plant.

3-2.5 Mix Design Checklist.

Summary of some important items to be included in the mix design

- 1. Gradation and properties of each aggregate used**
- 2. Percentage of each aggregate used in designed mixture**
- 3. Amount of natural sand**
- 4. Gradation along with gradation limits and plot of blend**
- 5. Compactive effort**
- 6. Calibration of mechanical hammer if used**
- 7. Data and volumetric calculations**
- 8. Plot of mixture properties vs. asphalt content**
- 9. Optimum asphalt content**
- 10. Grade of asphalt cement used**
- 11. Moisture susceptibility test results**
- 12. Percentage of RAP in mixture**

3-3 PLANT PRODUCTION.

3-3.1 Introduction.

QA personnel often believe that what happens at the HMA plant is a contractor issue and there is no need for government personnel to get involved with plant production. Government personnel must do what is necessary to know that the project quality is being controlled. This may require that the plant be inspected from time to time. In fact, the only way to know how much natural sand is being fed into the mixture is to measure the amount of sand being added to the mixture

at the asphalt plant during production. Also, the plant should be certified to perform state DOT work prior to being used to produce HMA for military work.

There are items that can be easily checked during mix production. First of all, a quick check of the plant area can confirm if the contractor has control over the handling of materials such as aggregates and asphalt binder. Poorly constructed stockpiles, stockpile contamination, or poor procedures for loading trucks are all indications of lack of control of mixture quality during plant production.

The QC laboratory, and QA laboratory if applicable, should be validated by the Corps of Engineers prior to performing any work on the project. The QC laboratory is typically located at the HMA plant. Hence, it will be easy to visit the QC lab and observe the plant setup and operation at the same time.

3-3.2 Stockpile Operations.

Gradation control for the asphalt mixture begins at the quarry but usually the location that the government first sees and becomes involved with the project is after the material has been placed in stockpiles at the asphalt plant. If there are issues at the quarry, this can be a problem and this may require a visit to the quarry to help to solve the problem. Whatever action is needed should be taken to make sure that a quality product is provided to the stockpiles.

Stockpiles must be created and maintained in a way that minimizes segregation and contamination in the stockpiles. If there are areas where the work is sloppy, the QC personnel should make sure that the problem is brought to the attention of the contractor and is appropriately handled. The government personnel should notify QC if a problem is observed and the problem is not being addressed. Many times a deficiency observed by QC personnel will not be corrected if QA does not take the initiative to make sure that QC addresses the problem. This is not the way that QC/QA is supposed to work but this is the way that it must sometimes be handled to encourage QC to adequately perform its job. If this problem of not reporting obvious deficiencies continues then some action needs to be taken to make changes in the QC organization.

Generally stockpiles should be created in layers to help ensure uniformity. This practice of building a stockpile in layers should be followed when initially building a stockpile and when new materials are added to an existing stockpile. It is poor practice to drop the material over the back or side of a stockpile as shown in Figure 3-6. This procedure can result in excessive segregation of the material (the coarser material tends to run down the side of the stockpile to the bottom of the pile) and it also creates a safety problem with the loaded truck backing up near the edge of the stockpile.

Stockpiles can be created on existing unpaved surfaces or on a paved surface. The paved surface has advantages in that it allows any water to drain out of and away from the stockpile quicker. The paved surface also minimizes waste material at the bottom of the stockpile since there is no need to be concerned with contamination from the underlying materials. However; it is more expensive, at least based in initial costs, to pave an area underneath a potential stockpile. When the area is not paved (Figure 3-7) the bucket loader needs to stay several inches above the underlying materials. When the bucket loader does get too low it can pick up some of the underlying material and contaminate a larger portion of the stockpile (Figure 3-8).

Figure 3-6 Improper Addition of Material to a Stockpile



Figure 3-7 Stockpile Created on Sandy Surface



Occasionally stockpiles will be contaminated with organic materials such as roots from bushes and small trees etc. Clay balls can also exist in stockpiles. The natural sand stockpile is the one most likely to be contaminated with organics or clay balls. It is very important to inspect stockpiles for any type of contamination or for any other problem such as segregation that might affect performance. If problems with organics or clay balls exist, the stockpile needs to be rejected. Contamination can sometimes occur when high winds blow unwanted materials into a stockpile. In some cases the fine aggregate stockpiles are placed downwind (based on prevailing winds) from the coarse aggregate stockpiles to minimize the fines blowing onto and contaminating the coarse aggregate.

Figure 3-8 Contamination of Stockpile from Underlying Materials



When there are problems with the stockpiles, the QC personnel should identify the problem, report it, and ensure that the contractor solves the problem. If QC continuously reports that there are no problems, even when some problems obviously exist, this is an indication that QC may not be doing an adequate job. All projects regardless of efforts by the contractor will typically experience problems at times. When these problems happen the QC should identify these problems and ensure that they are corrected.

3-3.3 Stockpile Checklist.

Things to look for in stockpiles

- 1. Stockpiles formed in way to minimize segregation**
- 2. No contamination from other stockpiles or underlying materials**
- 3. No organics or clayballs in stockpiles**
- 4. Loader operator properly works the face of stockpile**
- 5. Stockpiles built to ensure good drainage**

3-3.4 Hot Mix Asphalt Plants.

There are 2 general types of asphalt plants that are in use today, the drum mix plant and the batch plant. Clearly there are a lot more drum mix plants sold today than batch plants. The drum mix plants are typically more portable and have higher production rates than the batch type plants. There are still a large number of batch plants available but this number is being reduced each year as newer drum mix plants are replacing these older batch plants. Both plant types can produce high quality mixtures if set up and controlled correctly during production.

Typical layout of a batch plant is shown in Figure 3-9. A layout of a drum mix plant is shown in Figure 3-10.

Figure 3-9. Typical Batch Plant (From National Asphalt Pavement Association (NAPA))

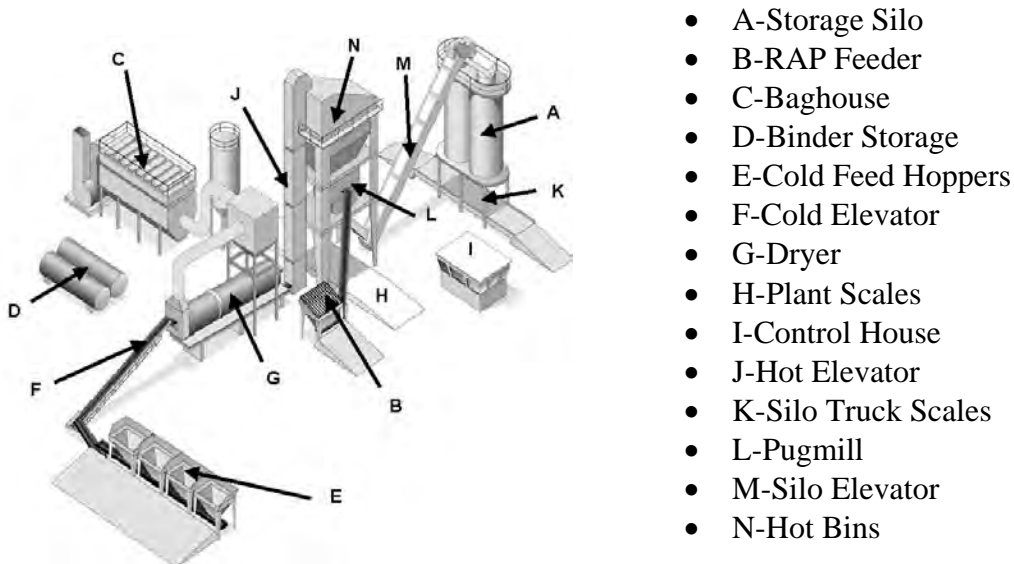
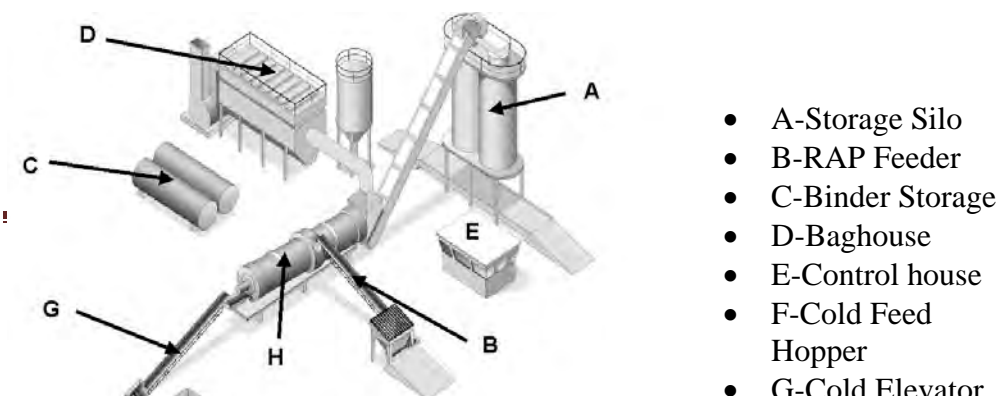

Figure 3-10 Typical Drum Mix Plant (From NAPA)



Regardless of the plant type, the feeders at the bottom of the aggregate hoppers should be calibrated so that the desired percentage of each aggregate is fed into the plant. If the plant is not properly calibrated, the desired aggregate gradation is not likely to be produced. Sometimes plant operators want to estimate the setting of these aggregate feeders and make adjustments as mix is produced and test results obtained. This is not a good approach since it can result in some less than desirable mix being produced while the plant is being adjusted. This trial and error process will result in more variability in the materials being produced adversely affecting performance.

The calibration process basically involves determining the rate of feed for each feeder, one at a time. The belt speed underneath a particular feeder is varied and the amount of material being fed into the plant per hour is determined. After taking several material flow measurements at each belt speed setting, the data is analyzed to determine the tons per hour of aggregate being fed into the plant for each setting. A plot is then typically made showing the relationship between tons per hour and belt speed. The plant operator can now set each belt feed setting so that the desired percentage of each aggregate is provided in accordance with the job mix formula and the desired total tons per hour of mixture being produced.

Typically each aggregate is fed from only one feeder. However, there are times, when using a high percentage of a particular aggregate, that it is advantageous to supply the aggregate through two or more feeders since one feeder may not have the capacity to provide enough material to meet the desired tons per hour. Another advantage of using two feeders is that the gradation will be averaged from these two feeders resulting in lower variation of materials in the finished product.

After the aggregate hoppers are calibrated, there are a number of items that can happen to affect this calibration. Materials will normally feed differently when wet and dry so one must be careful when the amount of moisture in the stockpile changes. In some cases this change in moisture can affect the final product due to its effect on feed rate. Sometimes some type of object such as a small root or clayballs can get into the hopper and alter the feed rate. Hence, even after calibration it is important that someone routinely inspect the feeders to ensure that all are feeding properly.

The natural sand is typically the most difficult material to feed since it will sometimes tend to bridge or plug due to the low volume of material being supplied to the mix. If a feeder is not feeding properly, a problem will likely show up when conducting material tests but problems caught earlier by visual observations can result in a significant savings if unacceptable mixture quality is being produced.

The mix production temperature is normally selected by the contractor based on past experience. In recent years, there has been a tendency for contractors to increase mixture temperatures to ensure that the mix will stay warm enough during hauling and placement so that it can be properly placed and compacted. Heating asphalt mixture to higher temperatures has a detrimental effect on the long term properties of the mixture. These high temperatures effectively drive off the light ends of the mixture and result in increased oxidation leading to a stiffer binder that will be more likely to crack and have other durability problems.

According to specifications, mixtures should never be heated to over 350 degrees F. Modified mixtures are often heated to temperatures approaching this maximum temperature but non modified mixtures are typically heated closer to approximately 300 degrees F. Excess temperatures will increase the cost for the contractor due to increased fuel use and eventually cost the government due to loss in pavement life.

After mixing, most mixtures are temporarily stored in a silo for a short period of time until the mixture is needed on the project. While some agencies have used mixes that have been stored for several days, mixtures for airfields should be used the same day as it is produced. If the silo is insulated then the mixture can be stored up to 8 hours but if not insulated the mix should not be stored for more than 3 hours. This long storage time can result in oxidation of the asphalt mixture resulting in a mixture that will have more of a tendency to crack during cold weather.

With some mixtures there is also potential for some of the asphalt binder to migrate down through the mixture resulting in segregation in the asphalt binder content. This problem may eventually result in localized fat spots on the pavement surface. While this is not typically a problem with normal dense graded mixtures it is a problem when using mixes with a higher coarse aggregate content such as stone matrix asphalt (SMA) and porous friction courses (PFC).

Once the mixture is produced, it needs to be handled in a way that reduces the potential for segregation. Segregation of the coarse material from the rest of the mix is a significant problem that has resulted in poor performance on many projects. There are many locations in the construction process where segregation can occur.

The silo is one location where segregation of the aggregate often occurs. The asphalt mixture should be loaded into a gob hopper at the top of the silo and dumped into the silo in batches. If the asphalt mixture is allowed to be continually fed into the silo, segregation will almost always occur as the coarser material tends to be thrown further from the belt and roll down the cone of material created at the top of the material in the silo. So, to prevent segregation, the material is fed into a hopper at the top of the silo and dropped in batches into the silo. This process decreases the amount of segregation that is observed.

There have been many cases where the gob hopper at the top of the silo was not functioning properly resulting in segregation. The contractor personnel that operate the plant generally know when there is a problem with the hopper but as long as mix is being produced and transported to the site, many operators will not stop mixture production until they are required to stop. When there is a problem with the gob hopper, it is likely one that cannot be seen by those simply inspecting the plant. The inspector might notice that the amount of segregation has suddenly increased and then when the problem is investigated, it can be determined that it is a problem with the gob hopper in the silo.

As needed, material that is loaded into a silo is fed into a truck for transport to the construction site. It is important that the material again be dropped in batches, when the truck is being loaded, to minimize segregation. These batches are created by opening the gate at the bottom of the silo for a short period of time and then closing the gate. These steps are repeated several times as a truck is loaded.

3-3.5 Asphalt Plant Checklist.

Things to look for at asphalt plant

- 1. Continuous operation**
- 2. Plant properly calibrated**
- 3. Satisfactory mixture temperature**
- 4. No excess moisture in mixture**
- 5. Proper operation of storage silo**
- 6. Proper sampling of mixture from truck**
- 7. Testing laboratory should be in good shape and be located at or near the asphalt plant**

3-4 TRANSPORTATION.

The truck beds, which will be loaded with asphalt mixture, need to be clean and not contain any material in the back of the truck that will contaminate the asphalt

mixture. A release agent is typically used to coat the truck bed to ensure that the mix does not stick to the sides and bottom of the bed. In the past, diesel fuel was often used as a release agent but this is no longer allowed by government agencies. The diesel fuel softens the asphalt binder and will tend to strip the asphalt binder off the aggregate with time.

When the mixture is exposed to diesel fuel during placement, there may not appear to be a problem right away but with time the diesel fuel under the action of traffic will strip the asphalt from the aggregate. There are a number of acceptable proprietary release agents that are used and it is up to the contractor to select one that is satisfactory. Observing the release agent application at the beginning of the project can identify problems before they become significant issues. This early identification of the problem will result in significant savings in time and money.

The best procedure to load a truck is to load the front or back first, the other end second, and the middle third last (Figure 3-11). This will help to minimize segregation by reducing the distance that coarser materials can roll during truck loading, hauling, and placement.

The most common location for in-place segregation is at the end of one truck load and the beginning of a second truck load of material. This is referred to as “end of truck load segregation.” The coarse material that segregates in a truck is typically at the front, back, and sides and this is generally the first and last material that is added from a truck, into the paver. This results in a tendency for segregation to show up where one truck load ends and the next truckload begins.

There are a few things that can be done to minimize end of truck load segregation. First the material can be loaded into the truck correctly as shown in Figure 3-11 to significantly reduce segregation inside the truck bed. Secondly material can be fed through a material transfer vehicle to remix the material and reduce segregation as discussed later. A third thing that can be done is to keep plenty of material in the paver hopper when paving. This will allow for some remixing of any segregated material that is fed into the hopper.

Figure 3-11 Typical Loadout Procedures for Hot Mix Asphalt

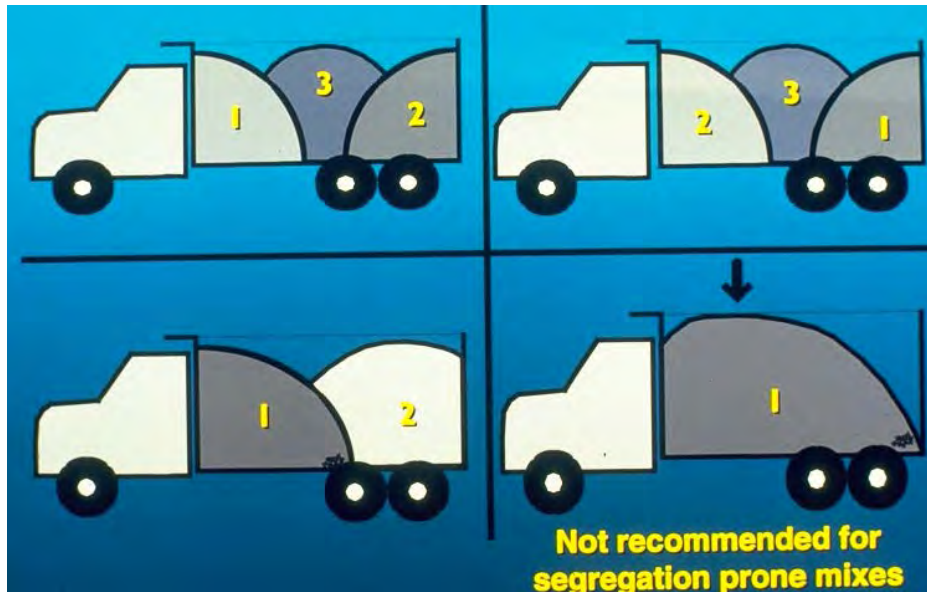

Insulated trucks are sometimes useful when hauling long distances and/or when hauling in cold weather. The mix tends to cool more quickly around the edge, top, and bottom and insulated trucks will help to reduce this cooling rate. In most cases insulated trucks are not necessary to be used on a project but they are helpful when paving in adverse conditions.

A mixture that cools too much during the haul will have cooler material around the top, bottom, and sides and warmer material near the middle of the truck. After the asphalt mixture passes into and through the paver, the mixture temperature may vary considerably from one location to another since there will not be complete remixing in the paver. This variability in temperature is likely to provide variability in compaction and it is expected the life of the pavement surface will be decreased due to this problem. This temperature variability problem, referred to as “temperature segregation” can be identified with an infrared camera as discussed later in the laydown discussion.

The trucks should be covered (Figure 3-12) to help hold heat in and to prevent any contamination while hauling from the plant to the laydown site. The cover should be in good shape and fit snugly around the truck and top of the asphalt mixture.

Figure 3-12 Use of Tarp to Cover Load



3-4.1 Trucking Checklist.

Things to look for in trucking

1. Proper loading procedures to minimize segregation
2. Truck beds clean before adding asphalt mixture
3. Acceptable release agent is used
4. Loads should be covered
5. Insulated trucks used for long haul distances/cold weather

3-5 SURFACE PREPARATION.

3-5.1 Introduction.

Asphalt mixture may be placed on an existing paved surface or it may be placed directly on a base course. When placed on a base course, there are several things that must be completed before placing the asphalt mixture. First, the base should be inspected and test results evaluated to ensure that adequate compaction has been obtained and to ensure there are no surface problems such as segregation, excessive scuffing under construction equipment, etc. If proof rolling is required, it is important that this be accomplished before covering the base course with HMA. It is also very important to ensure that the surface of the base course is at the desired elevation after being placed and compacted. Once it has been determined that the base course is satisfactory, it should be

primed with an asphalt material to protect the surface from rain and to help hold it in place under the equipment that may be required to operate on it.

Prior to start of an overlay project, some surface preparation for the existing surface is needed. If the surface of the layer being overlaid is in good condition, all that should be needed is the application of a tack coat. If there are cracks, these cracks should be sealed prior to overlay. If the existing pavement surface is old and in poor shape, the surface is often milled to level up and create a good textured surface on which to place the overlay. The milling operation will also remove small surface cracks and often reduce the severity of larger cracks since the crack width is usually wider at the top of the pavement.

After milling, any cracks still existing that are wider than $\frac{1}{4}$ inch should generally be sealed. If the cracks are less than $\frac{1}{4}$ inch then it is difficult to apply sealant inside the crack, hence these cracks are typically not sealed. When the sealant is properly applied to the cracks it will help to prevent moisture from getting into the underlying layer and result in improved performance of the pavement. If there are any localized damaged areas, these should be removed and replaced with quality materials prior to overlaying. The last step is to evenly apply the proper quantity of tack coat so that a good bond can be obtained between the underlying material and the overlay. Generally, the tack coat application rate should be 0.03 gallons per square yard up to approximately 0.1 gallons per square yard, depending on the condition of the surface being overlaid.

3-5.2 Milling and Grinding.

Milling and grinding are 2 processes that are often used to remove material from an asphalt surface. Milling is generally used to remove significant amounts of material prior to overlaying an existing surface. It is very common to remove 1 inch up to 3 or 4 inches using this milling process. Grinding, on the other hand, is a process to level the finished surface. For example if there is a bump or number of bumps in a pavement, these bumps can be removed using a grinding machine (Figure 3-13). This is done with a number of closely spaced saw blades. A surface on which grinding occurs provides a good riding surface and does not have to be covered, in fact; the surface is often not sealed after the grinding process.

Figure 3-13 Grinding of Pavement Surface



Milling of pavements (Figures 3-14 and 3-15) is a standard procedure that is used on many overlay projects to provide an improved surface on which the overlay can be applied. The primary purposes of milling are to remove the surface materials to a desired elevation, remove existing damaged material, and provide a highly textured surface that will help create a better bond with the overlay. The milling operation will also remove any excess sealant and any paint from the surface. There have been many pavement problems that have resulted due to excess sealant or paint on the surface prior to overlay and milling or grinding will solve this problem.

It is important to monitor the milling operation to ensure that the proper grade is being maintained and to ensure that the surface texture is satisfactory. Sometimes when milling close to an existing interface between two layers there is a tendency for some of the asphalt mixture to scab with part of the mixture being removed down to the interlayer due to lack of bond and the other material being removed down to some point slightly above the interface. This scabbing is undesirable and steps should be taken to minimize this problem. Preventing scabs might require that the depth of milling be altered, the machine be slowed, or the milling teeth be replaced or adjusted. For example, the number of milling teeth used on the drum can be adjusted resulting in different surface texture and different forces exerted on the mixture by the milling teeth. Hence, using more teeth will reduce the likelihood that this scabbing will occur.

Figure 3-14 Milling Operation



Figure 3-15 Close-up of Milling Drum

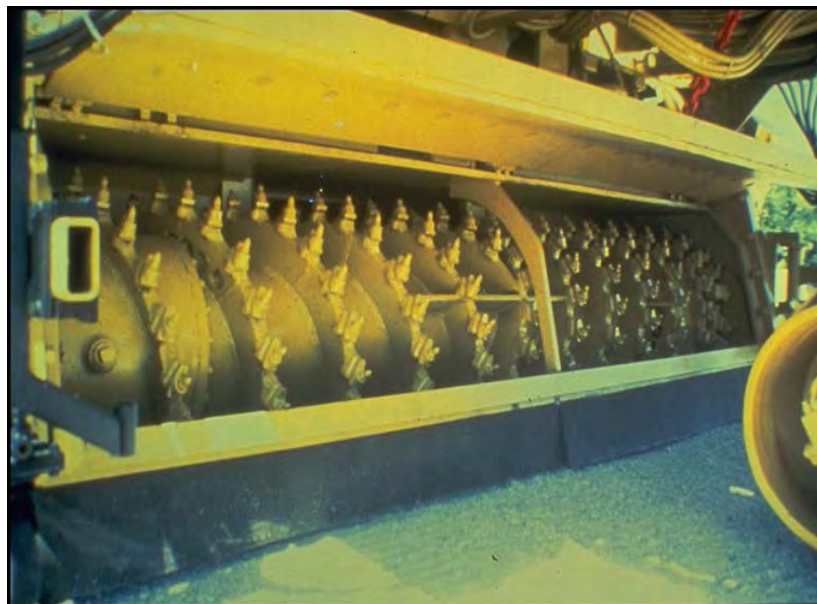

Milling is often required adjacent to small structures such as tie downs. This has to be done very carefully to minimize any damage to the structures. In this case a small milling machine such as the one shown in Figure 3-16 is used. The final surface after milling will typically look similar to that shown in Figure 3-17.

Figure 3-16 Small Milling Machine



Figure 3-17 Surface Milled with Small Milling Machine Adjacent to Tie Down



3-5.3 Crack Sealing

Prior to an overlay, the larger cracks (Figure 3-18) existing in the underlying mixture should be sealed. Smaller cracks (typically less than ¼ inch) that cannot be sealed without routing should typically not be sealed since it will take a lot of effort and the effectiveness of this sealing is not very good. When milling is performed the small cracks on the surface are removed and they are much smaller and tighter after being milled. Sealing cracks prior to overlay will not prevent or reduce reflective cracking but this will help prevent water from entering these cracks and getting into the underlying materials when the cracks reflect through the overlay. The finer cracks that are not active are not likely to reflect through the overlay.

Figure 3-18 Typical Crack that should be Sealed Prior to Overlay



Excess sealant should not be applied to the existing cracks (Figure 3-19). When excess sealant is used this is a waste of sealant resulting in increased costs. This excess sealant also creates a problem when overlaying the existing surface. The sealant will be softened when the hot overlay is placed resulting in slippage of the overlay during the rolling process and possibly later under traffic. This excess sealant will potentially result in cracking in the overlay immediately above the underlying sealant and often results in a bump at the crack. If excess sealant has been applied it should be removed and wasted prior to overlay. Many times there is excess sealant on the existing pavement from previous maintenance work. If the surface is milled, this will take care of the problem. If the surface is not milled then the excess sealant should be removed by scraping, sanding, or light grinding or milling prior to overlaying. In some cases, milling has been accomplished for the sole purpose of removing the excess sealant.

Generally the sealant should be placed in the crack and the top of the sealant should be below the surface of the pavement. However, there are processes where the crack is sealed and some of the sealant is placed on the edge of the adjacent pavement with a wand. This process works very well but the sealant and wand are designed to ensure a good bond between the sealant and the asphalt surface. This process is referred to as overbanding. A special type of sealant has to be used to ensure that the asphalt sealant does not track under traffic.

Figure 3-19 Excess Sealant



There are many types of sealant that can be used to seal cracks. Most include some type of polymer such as rubber to provide more elasticity to the material allowing it to stretch without breaking during temperature changes. Many sealant suppliers will provide guidance in applying their product for best performance.

If sealing cracks immediately prior to overlay with asphalt, be aware that the hot asphalt may excessively soften the sealer possibly resulting in it being absorbed into the new asphalt overlay resulting in a fat spot. As a minimum this soft sealant will allow movement of the asphalt layer while it is being rolled making it difficult to compact and often resulting in a bump above the existing crack. When large cracks are sealed it is better to use some type of sand mix to fill the crack otherwise excessive sealant will be required resulting in higher costs and increase possibility of mixture performance problems.

3-5.4 Repair of Local Damaged Areas.

Prior to overlaying an existing pavement, any local damaged areas should be repaired. In most cases this will involve removing the local poor quality materials and applying a patch. When the damaged materials are removed, the material should be removed a few inches into good material all around the patch and below the patch. This is required to ensure that all unsatisfactory material is removed.

When there are a number of small patches that must be repaired, it is better to combine these patches so that one or more large patches are constructed in place of a large number of small patches. The material is typically removed with some combination of saws, jackhammers, and small milling machines. After removing the material, the edges should be squared up and tacked prior to patching. The tack coat is needed to provide good bond between the new material and the existing material and it is also useful for sealing the joint to ensure that water does not penetrate through the joint into the underlying materials.

After tacking the edges, the hole should be filled with HMA so that when it is compacted it is level with the adjacent material. Lack of good compaction and segregation of materials are two of the biggest reasons that patches do not perform very well. To allow for compaction, the final layer to fill the hole must be applied approximately 20-25% thicker than the depth of the hole. This will provide enough material to allow for adequate compaction. When finished, the density should be adequate and the patch should be level with adjacent material. The thickness of layers will significantly affect the compactibility of the mixture. Generally the layer thickness should be at least 2 times the maximum aggregate size but not greater than approximately 3 to 4 inches.

Segregation of materials is a significant problem. Every effort should be taken to ensure that segregation is minimized. Material in bags or barrels can become segregated during filling and handling. Materials can also become segregated by throwing shovels full of material as opposed to using the shovel to place the material into the repair area. If the material does segregate, it will result in high coarse aggregate content, high air voids, low asphalt content, and generally a decrease in pavement life in the segregated areas.

3-5.5 Application of Tack Coat.

There are a number of materials that can be used as a tack coat and these materials may handle differently. The contractor should use the tack coat that is specified in the specifications. Some of the tack coat materials that have been

used include: emulsified asphalt, cutback asphalt, asphalt cement, modified asphalt, and trackless tack coat.

Any time a bound layer such as a concrete pavement or an asphalt pavement is being overlaid, a tack coat shall be used to help ensure a good bond between the existing surface and the overlay. If a new overlay consists of more than one layer, a tack coat shall be applied between all layers. All surfaces to receive tack coats and new asphalt overlays shall be thoroughly cleaned and swept (Figure 3-20) prior to tacking to insure good bond between layers.

Figure 3-20 Sweeper for Cleaning Pavement Surface Prior to Tacking



The typical tack coat application rate is 0.05 gallons per square yard up to 0.10 gallons per square yard. In some cases more tack material is needed but this is the range that is most commonly used. The amount of residual asphalt should be determined and the application based on this ratio. If the residual rate is higher than typical the application rate is reduced. A more absorptive surface will require a higher application rate than a tighter surface. A milled surface is generally more open and rough and therefore will usually require a higher application rate.

The tack coat is applied with an asphalt distributor (Figure 3-21) that should be properly calibrated so that an even spray at the desired rate is applied. This requires that all nozzles be clean, same size, and turned at the same angle. The spray bar height should be set to provide a double or triple lap.

An asphalt distributor is designed so that the amount of material pumped varies based on the vehicle speed so that the proper application rate is applied even if

the speed varies. Even though it is designed to apply the proper amount of material, problems still can occur. The nozzles are designed to apply a specific range in gallons per minute. When outside this range, an even flow of material and even application rate will not be obtained even if the average application rate is satisfactory. The nozzles may be dirty or the spray bar height may not be satisfactory resulting in an uneven flow rate as shown in Figure 3-22.

Typically, the locations where most problems occur are points of beginning and ending a spray application. These locations often end up with too much material applied (Figure 3-23) since the truck is accelerating or decelerating at these locations and the amount of material actually applied is sometimes higher than desired. When too much material is applied it should be removed by blotting with sand and sweeping the material up after blotting. After blotting it may be necessary to apply a light application of tack coat to ensure good bond but in some cases there is no need for additional material to be applied. This has to be a decision based on sound judgment.

Figure 3-21 Typical Asphalt Distributor



The spray should be an even application across the full width of the area being sprayed. If streaking or an otherwise uneven application is being applied, this is a problem and it can often be seen without taking measurements of spray rates. There are ways to measure the amount of material at different points underneath the spray bar by placing small paper pads at several locations underneath the spray bar and allowing them to absorb the asphalt that is sprayed. They can then be picked up and weighed to determine the application rate. Typical reasons for an uneven application rate are the spray bar not being set at the

needed height or the nozzles varying in size, being plugged, or turned at wrong angles.

Figure 3-22 Uneven Application of Tack Coat



Figure 3-23 Excess amount of Tack Coat

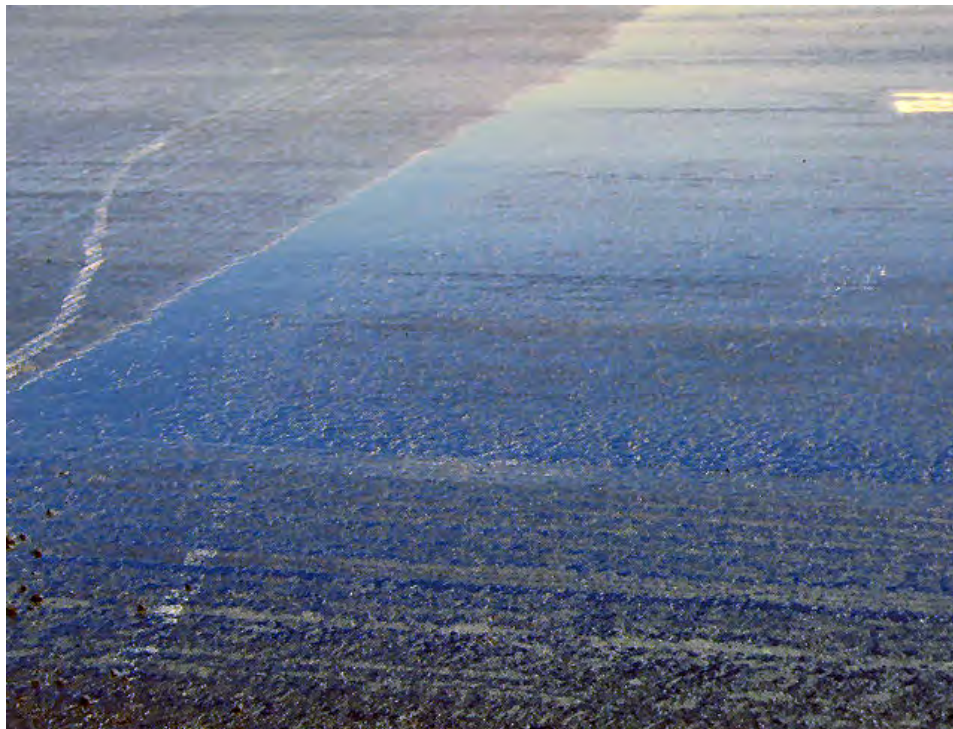

In locations adjacent to structures and other localized areas, the tack coat may have to be applied with a hand sprayer (Figure 3-24). This should be done in a way that provides a uniform application rate that is similar to the application rate being applied with the distributor. It takes an experienced person to get an even application rate with a hand sprayer.

Figure 3-24 Application of Tack Coat with Hand Sprayer



It is important that the recommended amount of tack coat be applied. If the application rate is too low or too high an adequate bond may not be obtained and slippage may result.

3-5.6 Application of Prime Coat.

Prior to placing asphalt mixture on an unbound layer such as aggregate base course, a prime coat (Figure 3-25) must be applied to the surface of the base course. The primary purpose of a prime coat is to protect the underlying base course from rainfall until the base course can be covered with HMA. Other purposes of the prime coat are to seal the voids in the surface of the base course and provide some protection from climate and construction traffic until it can be covered with asphalt.

Application of the prime coat material is similar to that of tack coat; however the amount of material applied is generally higher for prime coat. Once a prime coat is applied it must be allowed some time for the material to soak into the surface of the material being primed. Normally a minimum of 48 hours is allowed for the material to penetrate into the existing surface before being covered with HMA.

Tack and prime coats may encounter traffic; this material is then picked up by the truck/equipment tires and tracked on newly placed surfaces or pavements. This can result in an unsatisfied customer.

Figure 3-25 Prime Coat Application



3-5.7 Surface Preparation Checklist.

Things to look for in surface preparation

- 1. Milling is smooth to desired grade without scabs**
- 2. Cracks sealed if required**
- 3. Localized failures removed and replaced**
- 4. Paint removed prior to overlay**
- 5. All surfaces are clean and free of loose debris and dust**
- 6. Prime or tack coat properly applied**

3-6 PLACEMENT.

3-6.1 Introduction.

There are a number of ways that asphalt mixtures can be placed. Some methods are better for smoothness and some are better for costs, etc. This section will discuss methods of placing the asphalt mixture and identify some of the advantages and disadvantages of each method. Items that will be discussed in the following sections include: transferring material from truck to paver and laydown operations.

3-6.2 Transfer from Truck to Paver.

The objective during placement of asphalt mixture is to uniformly place the material produced by the plant to the desired thickness without any segregation. The asphalt material is transported by trucks and placed using one of the following 3 methods: placed in windrows and transferred to the paver with a pick up machine (Figures 3-26 and 3-27), dumped into the paver (Figure 3-28), or dumped into a material transfer vehicle (MTV) and then dumped into the paver (Figure 3-29). All three methods are often used and will be addressed here.

Figure 3-26 Placing of Windrow



The windrowing method is used extensively in the Western United States (US) but used little in the Eastern US. The advantage of using the windrowing method is that it allows the contractor to dump trucks quickly once the truck arrives at the laydown site so that each truck can quickly return to the plant for another load of asphalt mixture. One disadvantage of this approach is care must be used to ensure that the right amount of material is added to the windrows otherwise the paver will run low of material or extra material will be available that will have to be

removed before paving can continue. Another disadvantage of this approach is that there may be a large amount of material on the ground and if rainfall quickly begins, this material may have to be wasted. In addition, material deposited too far in advance of the paver, in colder temperatures, may result in the asphalt mixture cooling below an acceptable temperature range before placement and compaction can be completed.

Figure 3-27 Pick Up Machine for Windrowing Process.



Figure 3-28 Dumping Directly into Paver



The method that is used mostly in the eastern US is to dump the HMA directly into the paver. One significant problem with this procedure is that it is difficult to dump the HMA directly into the paver without creating some segregation. End of truck load segregation has been a problem for many years and this procedure, of dumping directly into the paver, makes the segregation issue a bigger issue. One advantage of this procedure is that it does not include an extra piece of equipment that has to be used in the unloading process. Another problem that is often encountered with this process is a buildup of trucks at the laydown site. If the paver is changing locations or is temporarily shut down, trucks may have to wait an extended period of time before unloading. Another disadvantage is that the paver tends to build roughness into the pavement as a result of the paver bumping the trucks as it comes in contact with each truck and when the paver is required to stop for a short period of time.

Figure 3-29 Use of Material Transfer Vehicle



The material transfer vehicle (MTV) has become more popular in recent years and is generally the preferred way to place HMA. This equipment has been shown to improve pavement smoothness since trucks do not have to come in contact with the paver. The paver operator simply has to be concerned with operating in a straight line that provides some overlap to the adjacent lane. Segregation has been shown to be significantly reduced due to the remixing of the material in the MTV prior to the material being fed into the paver.

In recent years there has been some emphasis on temperature segregation. This occurs primarily when the hot mix asphalt is being hauled a significant distance or in colder weather to the laydown site. The material around the sides, top, and bottom of the truck tend to cool more than that in the middle of the truck resulting in temperature segregation as shown in Figure 3-30. This figure was produced with an infrared camera that can accurately and clearly measure and show the temperatures of the pavement surface. The MTV has been shown to remix the material and reduce any problems with temperature segregation.

Figure 3-30 Temperature Segregation in an Asphalt Pavement Surface at Laydown

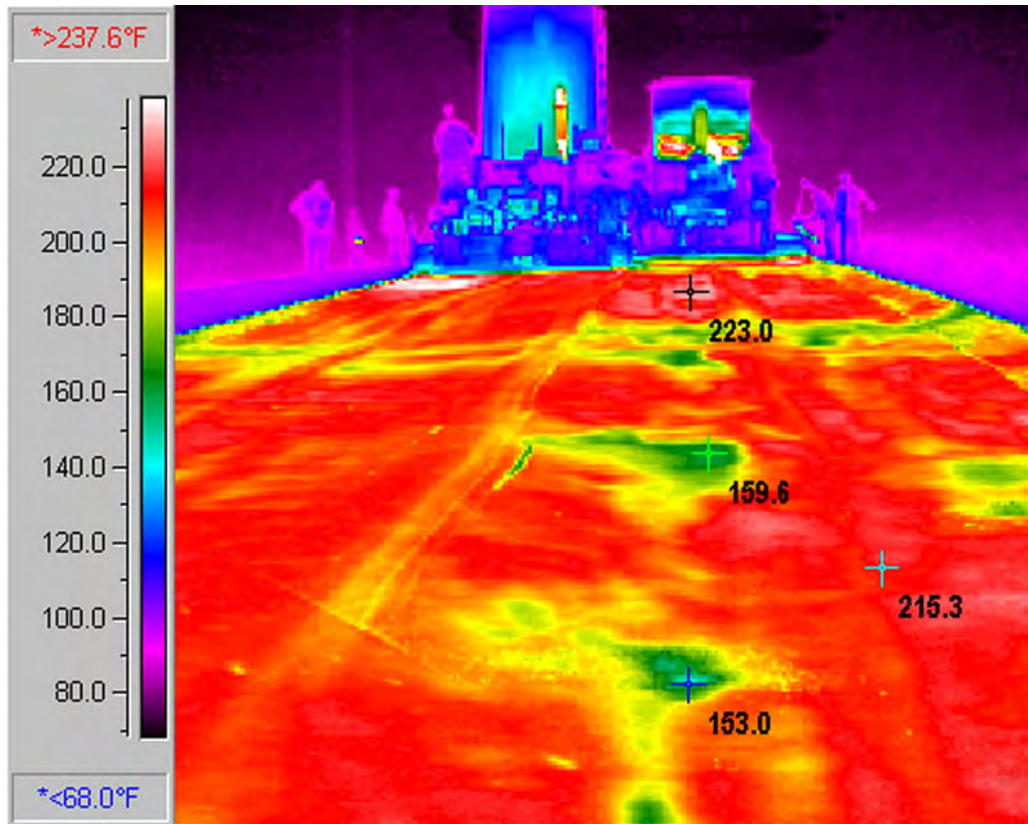

3-6.3 Laydown Operation.

Once the material has been placed into the paver, it should be handled and placed in a way that does not cause segregation (Figure 3-31) and that ensures a smooth uniform placement. If extensions are used on the paver, the extension should provide the same texture behind the extension as behind the rest of the paver. When the screed is extended, the auger should also be extended to no more than 2 feet from the side plate.

For best results the paver hopper should not be allowed to run low of material. This will likely result in more segregation of the mixture. Lifting the hopper wings to feed all of the material into the paver should be minimized. During the lifting of the wings, the coarse aggregate will tend to segregate and the variation of mix temperature being placed underneath the screed will increase since the material around the sides of the hopper tend to cool. Keep in mind that there will be compaction of the material after placement resulting in approximately 20-25% decrease in height. Hence the loose material must be placed thicker than the final compacted thickness to allow for adequate density to be obtained after compaction is complete.

Some of the biggest problems that are observed during the placing operation are problems related to paver extensions. The mix placed with the paver must be uniform from one side of the placed pavement to the other. If there is any location behind the screed where the surface is consistently non-uniform, the contractor should be required to investigate the problem and make changes to the process to address the problem.

Figure 3-31 Segregation of Asphalt Mixture



The flow of material through a typical paver is shown in Figure 3-32. The material is added into the hopper using one of the approaches discussed above. The HMA is then fed, typically with a slat conveyor, to the auger in front of the screed. The auger spreads the material in front of the screed so that a smooth uniform surface can be provided behind the screed. The rate of feed through the paver has to match the rate of placement behind the paver. The process should keep a constant head of material in front of the screed to ensure that the forces acting on the screed remain constant resulting in a smooth pavement surface.

Figure 3-32 Material Flow through a Paver

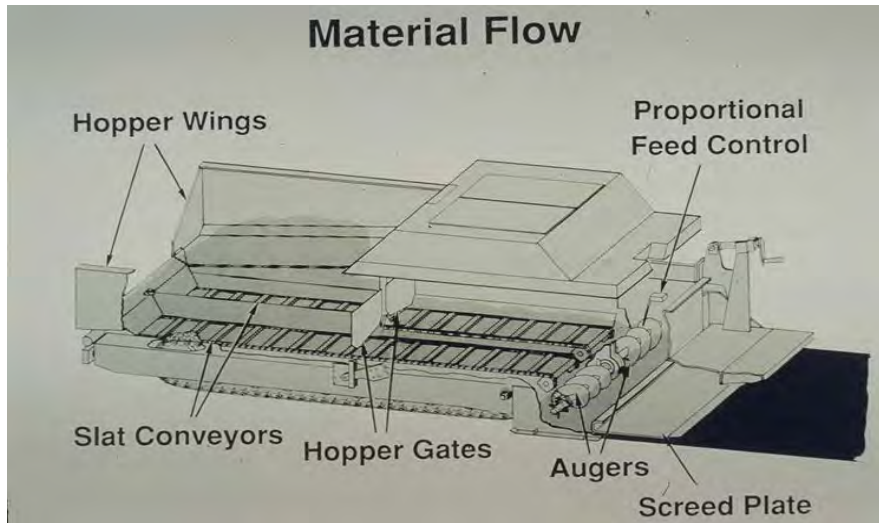

The screed is free floating (Figure 3-33) so that the paver can continuously produce a uniform smooth surface. The height of the screed (thickness of the placed loose mixture) is controlled by the forces acting on the screed. The forces acting on the screed include the tow bar pulling the screed, the weight of the screed, the upward force of the material underneath the screed, and the force of the material in front of the screed. The force is affected by the rate of travel, mix temperature, angle of the screed plate, the head of material in front of the screed, etc. All of these items have to remain constant to ensure a continuous uniform mat is constructed.

Figure 3-33 Vibrating Screed.



The material behind the screed should be uniformly placed without any pulling or tearing and compacted to some initial density. This initial density should allow

the mixture to support the rollers without undue displacement during the initial rolling process. When the paver moves too fast there will be a tendency for the mixture to be non-uniform and for the initial density to be lower than desired.

Many times there is some problem with the paver resulting in a non-uniform surface being placed (Figure 3-34). When this happens, the contractor should stop the paving operation until the cause(s) of the problem have been identified and corrected. The photo shows a more open texture near the middle of the paving lane. This is the result of a deficiency in the paving operations and the cause should be identified and solved before work continues. Also there is an open texture near the joint caused by the way the joint was raked. The joint was overlapped when the mixture was placed but the joint was improperly raked.

After placement of the second lane, the hot material that was overlapped onto the cold mat was then raked back onto the hot mat in a way that caused the coarse aggregate to segregate from the remaining aggregate resulting in coarse material being on the surface near the joint. This coarse material can lead to foreign object debris (FOD) issues as it dislodges from the HMA. The contractor should not be allowed to rake the joint in a way that results in this problem. The proper way to rake the joint is shown in Figure 3-35.

Figure 3-34 Uneven Surface after Compaction



As already mentioned there are a number of problems that often result due to use of paver extensions (Figure 3-36). The material placed behind an extension should have the same texture etc. as the mixture behind the main paver. The extensions are often lighter in weight and sometimes are actually hydraulic extensions that can be telescoped in and out. This can cause significant

problems when paving airfields. If extensions are used they should be heavy duty, matching the stiffness of the paver screed. Figure 3-36 also shows some material that had been broadcast across the mat resulting in coarse material on the surface that may result in FOD issues. This broadcasting of material should not be allowed.

Figure 3-35 Proper way to Rake Joint



Figure 3-36 Texture Difference Under Screed on Both Sides of Paver (Paver Extensions)



The augers should be extended when screed extensions are used so that material can be adequately moved to the ends of the screed. The end of the

augers should be within 2 feet of the side plate on the side of the paver. If the auger is not close enough to the side plate (Figure 3-37), the coarser material will tend to roll down the side of the asphalt mixture resulting in coarser material falling into the joint. This will make it very difficult to obtain the specified mixture density at the joint location and may result in a deficient joint if not corrected.

Figure 3-37. Excessive Distance between Auger and Side Plate



Many projects are designed to meet a specific grade on the surface of the compacted mixture. The typical ways to control this grade are to use a stringline, laser, or automated grade control with global positioning system (GPS). The use of a stringline is shown in Figure 3-38. If grade control is required, one of these 3 methods should be used and the finished surface should be evaluated shortly after initial work is completed to ensure that the design grade is being obtained. Checking the grade early in the process will allow changes to be quickly made any minimize the problem. However, waiting until the project is complete to check the grade is risky since a problem at that point will be very difficult to correct. Hence, catch the problem early so that corrections can be easily made without having a lot of material in place that will have to be corrected.

Sometimes there will be areas that are slightly low or slightly high in the completed surface. When an area is a little low, it is not acceptable to apply a thin layer of asphalt mixture as a skin patch (Figure 3-39). Skin patches typically begin to ravel with time resulting in loss of material and FOD. If there is a low spot in the completed surface there are really two feasible options. One is to leave it in place if the problem is not too bad. The other option is to remove and patch the low spot with enough material to solve the problem.

When removing material, it should be removed to a depth of at least 2 inches. The easiest way to accomplish this removal is with a milling machine. Regardless of how much effort the contractor puts into constructing the patch, there are limits to how well a patch can be constructed. Hence, make sure that the existing low spot that is being considered for repair will be improved when a typical patch is completed.

Figure 3-38 Use of Stringline to Control Grade



Figure 3-39 Skin Patching Should not be Allowed on the Surface



It is very difficult to construct a longitudinal joint that will perform as well as the adjacent mat. There are steps that can be taken to improve the quality of the

longitudinal joint. The biggest cause of problems at the joint is the inability of the contractor to obtain adequate density. There have been many projects built using different techniques and the one that works best for cold joints is to cutback the loosely compacted edge to form a vertical dense edge to place against.

It is recommended that the edge of paving lanes that have been allowed to cool be cutback with a cutting wheel (Figure 3-40) or similar device prior to placing the adjacent lane. Generally cutting back the edge by at least 2 inches will be sufficient to allow for adequate compaction in the joint when the adjacent lane is placed. Remove all cutback joint materials and then apply a tack coat to the edge to ensure the joint is sealed and to facilitate obtaining adequate joint density when the adjacent lane is placed. After the edge has been cut back, the excess material removed, and the joint tacked, the adjacent lane is placed using normal construction techniques and compaction is performed using methods that will be discussed later in the chapter on compaction.

Many other processes have been tried for obtaining satisfactory density in longitudinal joints but cutting back the loose material with a cutting wheel has proven to be the most consistent way to obtain a high quality joint. Procedures that are not recommended to be used include butt joint, tapered edge (Figure 3-41), and joint heater (Figure 3-42).

When placing mix in cold weather or when trying to place it too thin for the maximum aggregate size being used, some pulling and tearing may result causing the surface to be non-uniform and undesirable. Many times slowing the paver down will be sufficient to solve this problem. This problem can also be caused if the mix is not sufficiently hot and/or if the bottom of the paver screed is not properly cleaned and in good shape.

Figure 3-40 Use of Cutting Wheel to Cutback Edge of Existing Lane



Figure 3-41 Use of Tapered Longitudinal Joint is not Desired

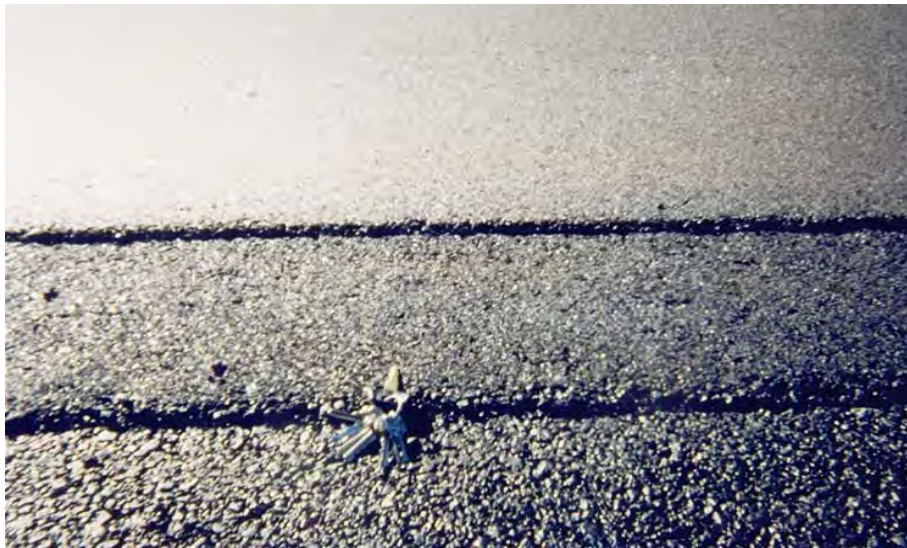

Figure 3-42 Use of Joint Heater is not Desired



3-6.4 HMA Placement Checklist

Things to look for in placement

- 1. Use material transfer vehicle**
- 2. Tack coat in good shape**
- 3. No segregation, pulling, or tearing behind paver**
- 4. Uniform surface texture behind paver**
- 5. Paver does not start and stop**
- 6. Do not use joint heaters**
- 7. Longitudinal joints cutback with cutting wheel**
- 8. No tapered joints**
- 9. Paver extensions working properly**

3-7 COMPACTION.

3-7.1 Introduction.

Good compaction of asphalt mixtures is considered to be one of the most important steps to ensure good performance. Compaction is needed to provide good strength, to minimize additional compaction under traffic, to produce an impermeable mixture, and to prevent rapid oxidation of the mixture. The location where problems caused by poor compaction generally show up first is in the

longitudinal joints where it is difficult to obtain adequate compaction. An example of what can happen if good density in the longitudinal joint is not obtained is provided in Figure 3-43. This is a 9 year old pavement that failed due primarily to poor quality in the longitudinal joints.

Figure 3-43 Raveling in Longitudinal Joint due to Poor Compaction



3-7.2 Compaction Equipment and Procedures.

Rolling is typically broken down into the 3 zones of rolling: breakdown, intermediate, and finish rolling. The breakdown rolling is the initial rolling of an asphalt mixture and is typically performed with a vibratory steel wheel roller (Figure 3-44). In a few cases when a very tender asphalt mixture is being compacted, a rubber tire roller has been used for breakdown rolling. Much of the density is obtained during breakdown rolling but the remainder of the density and the most difficult part to achieve is obtained with the intermediate rolling. The rollers used for intermediate rolling generally include vibratory steel wheel rollers and rubber tire rollers (Figure 3-45).

The vibratory roller has been shown to be a good roller to use for breakdown of the mix. This roller tends to provide good compaction and does a good job of providing a good tight smooth surface. It is important that the frequency of the drum be high (approximately 3000 vpm) since this has proven to work best for asphalt mixtures. Experience has shown that most mixes can be rolled some maximum number of times with a steel wheel roller and then these mixtures begin to push with additional rolling developing hairline cracks called “checking” (Figure 3-46). The first few passes with a steel wheel roller can typically be accomplished resulting in some level of compaction without causing any problems in the asphalt mixture. However, after the asphalt mixture has been

rolled more than this maximum number of times, the mixture begins to move laterally with additional rolling sometimes resulting in loss of bond between the asphalt mixture and the underlying layer. This lateral movement will also result in difficulty in obtaining the required density and may actually result in some loss in density. Hence, make sure that the contractor does not excessively roll the asphalt mixture with the vibratory steel wheel roller or even static steel wheel roller resulting in this lateral movement. For mixes that begin to move laterally before adequate density can be obtained, consider using a rubber tire roller.

Figure 3-44 Typical Vibratory Steel Wheel Roller



Figure 3-45 Typical Rubber Tire Roller



Rubber tire rollers have been shown to be effective in obtaining good density in asphalt mixtures. Rubber tire rollers can be used without having to be concerned with this lateral movement that results when using steel wheel rollers. Regardless of the number of passes, the rubber tire rollers don't cause this checking and can actually tend to reduce the amount of hairline cracking caused by over rolling with steel wheel rollers. For airfield pavements, it is recommended that the rubber tire roller weigh approximately 4500 pounds per tire and the tire inflation pressure be approximately 90 psi. Many contractors don't prefer using rubber tire rollers due to their potential to pick up asphalt material and their additional cost but they are very useful as a part of the compaction process. Several methods have been used for minimizing pick up including ensuring the tires are hot when rolling the asphalt mixture and using some type of release agent (soapy water or one of several proprietary release agents but not diesel or any other type of petroleum product) on the rubber tires.

Figure 3-46 Checking Under Steel Wheel Rollers



Finish rolling is typically performed with a static steel wheel roller or with a vibratory steel wheel roller with the vibrator in the off position. The primary purpose of the finish roller is to smooth out roller marks or any other small bumps or depressions that may be in the surface of the asphalt mixture. The finish rolling often operates a considerable distance behind the breakdown and intermediate rolling otherwise lateral movement and other problems may occur in the mixture under this steel wheel roller. Observe the finish roller to ensure that these hairline cracks are not being produced while being rolled with the finish roller.

The mix temperature is very important for good compaction. If the temperature is too hot the mix will tend to push and shove when rolled making it difficult to obtain adequate density. If the mix is too cold, the mix will tend to be stiff making it difficult to place and compact to an acceptable density level.

The best temperature for rolling is typically determined based on past experience. For most mixtures this is approximately 300 degrees F or a little less when compaction begins. If a polymer modified binder is used, generally the temperature of the mixture will have to be a little higher. The specifications place an upper limit on mixture temperature at approximately 350 degrees F. This is the absolute maximum and should generally not be approached during construction. As the temperature is increased, the amount of damage to the asphalt binder is increased resulting in loss of pavement life. This damage to the asphalt binder begins to expedite when heated to near 350 degrees F.

The mix should be rolled in a way that provides a smooth surface without any bumps or other surface defects. This requires that rollers move slowly and make gradual turns to ensure that marks are not excessive and these marks can be rolled out with reasonable effort (Figure 3-47). If rollers stop on the hot surface for a significant amount of time, they will create depressions that can't be rolled out during the rolling process.

Figure 3-47 Excessive Roller Marks



Developing a rolling pattern is important to obtaining optimum density. Most contractors have experience with their materials and mixtures and only need to tweak the rolling pattern used in the past to obtain satisfactory density. At times, some effort is required to evaluate different rolling patterns to determine the optimum procedure when an unfamiliar mixture is being compacted. This revised rolling pattern can be evaluated during construction of the test section to determine if the pattern is adequate. If there is a problem in obtaining density during construction of the test section, then the roller pattern, roller types, or roller operators may have to be changed to improve compaction.

3-7.3 Transverse Joints.

Transverse joints are difficult to construct and compact in a way that provides smoothness across the joint and adequate density. The paving plan for the project should be developed in a way that will minimize the number of transverse joints. Typically, these joints are required at the end of the day or at points where a delay in paving is long enough to require a joint to be constructed. Quick checks on the quality of the joint can be made by visually inspecting to ensure no significant segregation, using a straightedge smoothness, and using a density gage to obtain a quick estimate of density.

One of the more common issues that occur during the construction of a transverse joint is failure to remove sufficient material at the end of the previous construction adjacent to the joint to expose a vertical edge that is full thickness of the layer being placed. When the cold side of the joint is originally placed there is a tendency for the end of the paving lane to be rounded over a little due to the rolling process. Hence, a straightedge should be used to check the smoothness of this cold paving lane before beginning construction on the hot side of the joint. If the end portion of the work is not smooth and/or tends to be slightly rounded then material should be cutback to a point where there is smoothness and adequate thickness.

As soon as work is underway on the hot side of the joint, be sure to use the straightedge to check across the joint to ensure that adequate smoothness is being obtained. There are several ways to construct the transverse joint but, either way, the material on the cold side has to be removed by sawing or cutting with a small milling machine back far enough to provide a smooth surface with adequate thickness.

When the hot side of the transverse joint is constructed it must be placed with the paver approximately 20-25% higher than the cold compacted side to allow for adequate compaction. Typically, at start up, small strips of wood or other material are placed on the existing compacted cold surface underneath the paver screed to provide this additional thickness as the paver pulls off of the cold side. The paver is set on these strips so that the desired initial thickness is obtained.

During rolling adjacent to the joint the mix may tend to move underneath the rollers. For example, when rolling from the hot side to the cold side, the hot mix may tend to be pushed up on the cold side. When rolling from the cold side toward the hot side, the hot mix will tend to be pushed away from the joint resulting in a small dip in the surface immediately past the joint and a bump a

little further away from the joint. To help minimize any problems from this movement, the mix in and adjacent to the joint can be rolled in a transverse direction. This approach will help to provide density and help to remove any surface smoothness deficiencies.

3-7.4 Longitudinal Joints.

Longitudinal joints are placed as discussed in the section on laydown. The joint should be rolled first since it is the most difficult portion of the mixture to be compacted. There are a number of ways to roll the joint but the most important thing is, when finished, the joint should meet density, smoothness, and mixture quality requirements. The use of a rubber tire roller to help compact the joint is desirable since the kneading action of this roller will help to ensure better compaction of the mixture in and adjacent to the joint. As always, when using the rubber tire roller, be sure that excessive pick up of the mixture on the rubber tires does not occur.

Initial compaction of the longitudinal joint should be performed before rolling the mat. There are 3 ways that are generally used to compact the joint; vibratory roller on cold mat overlapping 6 inches on hot mat (run in static mode), vibratory roller on hot mat overlapping 6 inches on cold mat (run in vibratory mode), or keep vibratory roller on hot mat and 6 inches away from joint (run in vibratory mode) then roll this 6 inches of remaining material on the next pass. All 3 of these methods have been used successfully. Keep in mind that the way the contractor rolls the joint is not overly important but it is important that they meet density and smoothness requirements when finished and there is no segregation in or adjacent to the joint.

There are two ways that are generally used to construct a joint with acceptable density. One approach is to place the second lane before the first lane has cooled creating a hot longitudinal joint. This type of joint can be compacted without too much difficulty since both sides of the joint are hot when constructed. The second approach involves constructing a joint after the first lane has cooled. In this case the best approach is to cut back the edge with a cutting wheel as shown in Figure 3-40 to remove the loose material at the edge and provide a dense vertical face to place against. The adjacent lane can be placed against this first lane in a way that good compaction can be obtained.

3-7.5 Density Measurement.

There are several ways to measure density of asphalt mixture including cores (Figure 3-48) and density gages (Figure 3-49). The density gages (nuclear and non-nuclear) are good for control of compaction but not acceptable for density

acceptance testing. There are too many issues with density gages to be used for acceptance and even under best circumstances the result of these gages must be compared to cores obtained from the pavement for calibration and continued validation of accuracy.

Figure 3-48 Cutting Cores for Density Testing



Figure 3-49 Density Measurement with Density Gage



3-7.6 Factors that affect compaction.

There are several factors that affect compaction. Some of these factors include: layer thickness, air temperature, mix temperature, wind speed, bond to underlying layer, types of rollers, rolling pattern, condition of roller, and many others.

Generally within the range of layer thicknesses used on airfields, thicker layers are easier to compact than thinner layers. Thinner sections tend to cool quicker and they result in some bridging of the aggregate making compaction of the mixture difficult. As a result thicker sections are easier to compact. However, it is more difficult to maintain good smoothness for thicker sections. Generally the minimum layer thickness should be at least 2 times the maximum aggregate size or 3 times the nominal maximum aggregate size (defined as one sieve size larger than the first sieve size that has less than 90 percent passing). This is a minimum recommendation for thickness, hence, the layer should not be thinner but is acceptable to be thicker.

The lower the air temperature the more difficult an asphalt mixture is to compact. The primary reason for this is that the mixture cools quicker during cooler weather resulting in less time to roll and compact the mixture. When paving in cooler weather the number of rollers needed for compaction may be higher since the amount of rolling time before the mixture cools is reduced. Increasing the speed of rollers generally reduces the efficiency of a roller to compact so speeding up rollers to provide the roller pattern in less time is usually not a good option. Hence, less rolling time often translates into the need for more rolling equipment.

The mixture temperature is very important for compaction. If the temperature is too high, the rollers will have to wait until the mixture cools some before rolling. This is undesirable. If the mixture is too cool, good handling characteristics and adequate compaction will not be possible. The mixture should be placed at a temperature at which it can be rolled immediately. Generally, the rollers should stay close behind the paver for best compaction. When paving in cooler weather some contractors tend to increase the mixture temperature to allow more time for compaction. A small increase in temperature may be acceptable but any significant increase will again result in the rollers having to wait for the mix to cool before rolling begins which is undesirable.

Increased wind velocity will make obtaining adequate compaction more difficult. Higher wind velocity will increase the rate of cooling thus decrease the amount of time for compaction. Hence, paving during windy conditions will be more difficult to obtain adequate density than when paving in little or no wind.

Sometimes adequate density is difficult to obtain due to lack of sufficient bond to the underlying layer. A good tack coat is needed for a good bond. When there is poor bond, there is a much higher tendency for the mixture to move laterally

during rolling resulting in checking. When checking occurs, it is very difficult to meet the minimum density requirements. This lateral movement and checking may eventually lead to slippage of the layer when subjected to traffic. Good bond is essential for good compaction.

Certainly the types of rollers, condition of rollers, rolling pattern, and experience of the rolling operators are critical for good compaction. All rollers should be in good shape and the operators should be experienced. The rolling pattern selected should be one that has worked satisfactorily on previous projects. Rubber tire rollers should generally weigh at least 4500 pounds per tire and should have approximately 90 psi tire pressure. Vibratory rollers generally weigh 10 to 12 tons and should generally have a frequency high enough to give at least 10-15 tamps per foot. If the frequency is too low a washboard effect occurs resulting in loss of surface smoothness.

3-7.7 Compaction Checklist.

Things to look for during compaction

- 1. Rollers in good shape**
- 2. Sufficient size and number of rollers**
- 3. Use proper release agent on the rubber tires. No diesel should be used**
- 4. Good rolling pattern**
- 5. Air temperature satisfactory**
- 6. Mix temperature satisfactory**
- 7. Mix should support rollers without lateral movement**
- 8. Layer thickness satisfactory**
- 9. Rollers keep up close behind paver**
- 10. Good procedures with longitudinal and transverse joints**

3-8 QC/QA TESTING AND ANALYSIS.

3-8.1 Introduction.

QC and QA are very important components of the quality management system. QC is the responsibility of the contractor and must be conducted to ensure that the constructed quality is controlled throughout the construction process. Part of the QC involves identifying and documenting problem areas and providing solutions to these problems. QA is the responsibility of the government and is responsible for assuring that quality control is working the way it should be and a quality product is being delivered by the contractor. An effective QA representative must have a good understanding of materials, materials testing,

and the construction process. It is difficult for the QA to properly monitor the QC when the QA personnel do not fully understand the technical aspects of the project. The information provided below will help to provide information necessary to enhance effectiveness of QC and QA personnel.

3-8.2 Quality Control.

The contractor is required to provide a quality control plan for approval and to implement this plan to ensure that a quality product is constructed. This plan should provide a clear description of inspections, tests, and other steps that will be taken to control the overall quality of construction. This plan should answer a number of questions. How will the aggregate gradation be controlled? How will the mixture volumetrics be controlled? What will be done if material does not meet the specification requirements? When will QC reports be provided to the government? These are just a few of the many questions that should be answered.

Unfortunately, many times this plan is only submitted because it is a specification requirement and, once approved, it may not be looked at again. The plan should be reviewed on a regular basis and changed, if necessary, to improve the control of quality of the HMA being produced.

Many problems that occur on projects are the result of failure to maintain good communications between all involved in the project. Good communication between the QA and QC staff is necessary to prevent problems that might otherwise occur.

It is important that the QC laboratory be located near the asphalt production plant if possible. There are times when the lab is located at other places but most contractors locate the laboratory adjacent to the plant facility. Most sampling of the mix will be performed at the plant and having the laboratory nearby will allow testing to be performed without having to transport the samples some distance to another laboratory. It is important that the HMA samples do not cool down before compaction of the mix in the laboratory is conducted. Reheating of samples is not allowed in the specifications since this reheating will provide some stiffening of the binder and change the properties of the mixture.

It is important that the QC test results be provided to the government in a timely manner. The report should be provided to QA within the time frame specified in the quality control plan. Generally the report should be provided within 24 to 48 hours after the work is completed. In most cases 24 hours after a day of construction is long enough to allow the QC organization to provide a report. The report should provide laboratory test results, inspection observations, identify any results that are outside the specification requirements, and provide a plan for what actions will be or were taken based on test results and inspections.

There are a number of items that will have to be evaluated as a part of QC during the project. Some of these items include: aggregate gradation, asphalt content, air voids, voids in mineral aggregate, stability, flow, in-place density in the joint and mat, smoothness, thickness, and grade of the completed surface. Inspections will be made to ensure that the completed mix is uniform with no segregation or other problems and that the overall quality of the in place mixture is satisfactory.

Many times there are localized problem areas that have to be dealt with. These areas will likely not be included in the random testing, so any of these localized problems must be identified visually and evaluated separately from the random testing. Most of the time, if there is an obvious localized mixture problem, the contractor will take the necessary action to correct the problem without having to perform additional testing.

There are two types of samples that can be taken during quality control; representative and random. For mix design, representative samples should be taken. For testing during production, random samples should normally be taken. Representative samples are taken in a way that provides test results equal to the average properties of the material being sampled. For example, a representative sample of an aggregate stockpile should be taken in a way that provides a gradation equal to the average stockpile gradation. This representative sample typically involves taking a number of random samples and blending them together to produce a representative sample.

Random samples are taken in a way so that each possible sampling location has an equal chance of being selected. A random sample will be taken at one random location or at one random point in time during the mixture production operation. Random locations are selected by using some type of random number generator. The process of random samples ensures that there is no bias in taking the samples. Samples that look good or bad are not considered in the random sampling plan; it is strictly a random approach to sampling. As noted earlier, one problem with this approach is that there may be areas of pavement that are visually deficient but no random sample is identified to be taken in these areas.

3-8.3 Control Charts.

Control charts should be plotted so that data can be summarized graphically. These plots can help to show trends in data and can help in identifying “cause and effect” when there is a mixture problem. Typically a control chart should show the upper control and lower control limits (normally this is set as the specification limits) as well as plots of individual test results and running average test results. An example of a control chart for density, as percent of theoretical

maximum density (TMD), is provided in Figure 3-50. Control charts that are typically plotted include: aggregate gradation, asphalt content, voids in total mix, mat density, and joint density.

Figure 3-50 Quality Control Chart for Density

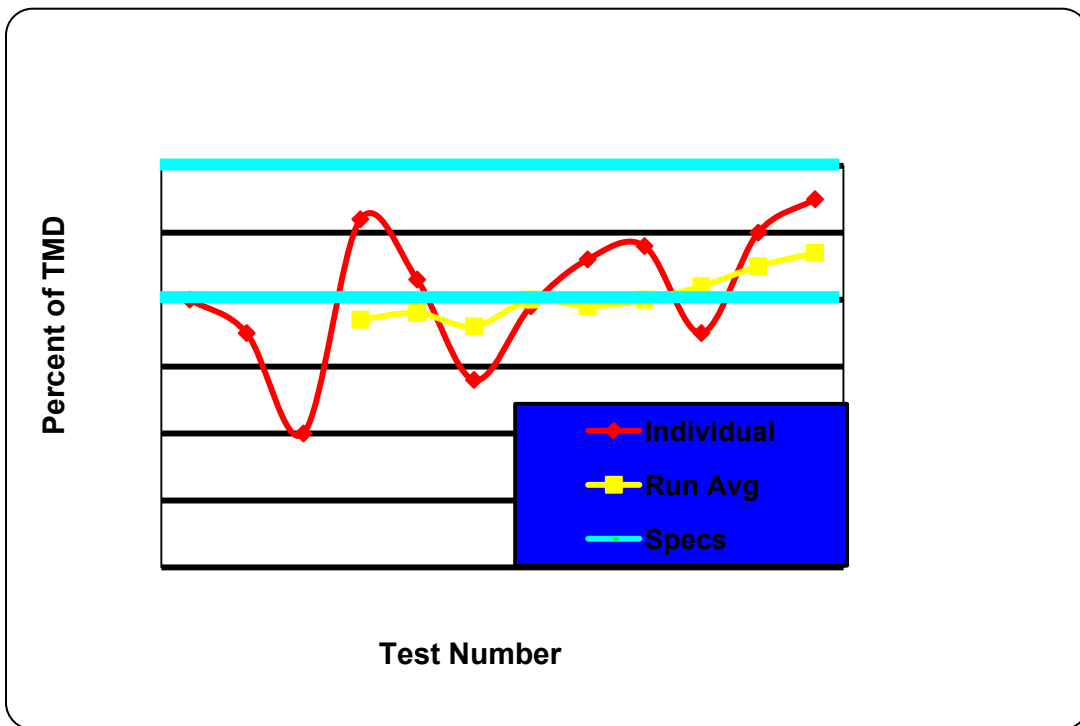

3-8.4 Aggregate Gradation.

The gradation of the various aggregate sources and the blend of aggregates from these sources must be consistent to ensure a high quality mixture is produced. Sufficient testing must be performed to ensure that the aggregate gradation in the completed mixture continues to meet the specification requirements and have low variability. This requires testing of aggregates being delivered to the HMA plant, testing of the cold feed blended aggregate, and testing of the aggregate recovered from asphalt mixture. The quality control plan should address the details of how this sampling and testing will be performed and the QC reports should provide the test results.

The specifications provide tolerances for each sieve size and it is important that the test results meet these tolerances. Failure to meet these tolerances will have an effect on the air voids and voids in mineral aggregate resulting in these properties likely being outside the specification requirements resulting in some loss in overall mixture quality.

The mixture quality is very sensitive to variations in the amount of material passing the No. 200 sieve. If the percent passing the No. 200 sieve increases during plant production, this will almost always result in a decrease in air voids and a decrease in voids in mineral aggregate. If the percent passing the No. 200 sieve decreases during plant production an opposite trend will be observed. The HMA is very sensitive to the air voids so these variations can significantly affect the quality of the HMA.

The measured gradations of aggregate recovered from the mixture should be plotted on control charts. Typically 2 or 3 critical sieve sizes are selected for plotting (the two most common sieves that are plotted are the No. 200 and the No. 4 sieves). These control charts should be updated daily so that they are available to help evaluate the overall quality of mixture as construction proceeds.

3-8.5 Asphalt Content.

The amount of asphalt binder in a mixture is one of the most critical items in the control of asphalt mixture. If the asphalt content is too low, the air voids will tend to be high and the mixture will be difficult to compact. The mix will tend to be permeable to air and water and is likely to have durability problems. If the asphalt content is too high, the air voids will be low eventually leading to bleeding of the mixture and possible rutting.

Typically, samples of asphalt mixture are taken from a loaded truck at the HMA plant and tested by ignition (ASTM D 6307) or solvent extraction (ASTM D 2172) to determine the amount of asphalt. When conducting tests be sure that mix is either dried before testing or there is a correction for moisture. The testing laboratory should develop a calibration factor for the ignition test that corrects for the expected amount of aggregate loss. Be sure when the solvent extraction is used, all of the asphalt binder is removed from the mix before completing the washings with the solvent.

If the asphalt content is low, then the theoretical maximum density (TMD) should be higher since aggregate is more dense than asphalt binder. So, a good way to confirm if the asphalt content test is reasonable is to see if the change in theoretical maximum density correlates to the change in the measured asphalt content.

3-8.6 Air Voids.

Air voids (ASTM D 3203) are very important in ensuring good mixture performance. The amount of air voids is used to determine the optimum amount of asphalt during the mix design process. The total asphalt content in the mixture is important primarily due to its effect on the air voids. Higher asphalt content produces lower air voids typically resulting in bleeding or possibly rutting under traffic. Lower asphalt content produces higher air voids typically resulting in long term durability issues.

It is important that air voids be closely controlled. To accurately measure the laboratory air voids requires that proper samples of the asphalt mixture be obtained. Secondly, the sample must be compacted within the desired temperature range using the correct compactive effort. For airfields this compactive effort is 75 blows per face with a manual Marshall hammer. If Superpave is used, the mix shall be compacted with 75 gyrations with the Superpave gyratory compactor. A mechanical hammer can be used if properly calibrated to provide a density equal to that obtained with the manual hammer. Third, the bulk density of the compacted sample(s) (ASTM D 2726) must be determined by weighing in air and submerged in water. A sample of the loose mixture must be tested to determine the theoretical maximum density (TMD) (ASTM D 2041). The TMD is the density which would provide zero air voids in the mixture. In other words, it is a measure of the density that would be obtained if all of the air could be squeezed out of the mixture by compaction.

During production, the mixture will generally be adjusted slightly to provide air voids near the middle of the specification band. This change is normally accomplished by adjusting the asphalt content. If the voids are a little low, then lower the asphalt content slightly. If the voids are a little high, then increase the asphalt content slightly.

3-8.7 Voids in Mineral Aggregate.

The VMA (ASTM D 6995) is important to ensure that there is room in the mixture for a reasonable amount of asphalt binder. The VMA is defined as the volume of space and material in between the aggregate particles as a percentage of the volume of the total mixture. Hence, in an asphalt mixture this volume of space in between the aggregate particles includes the air voids and the asphalt binder that is not absorbed into the aggregate. VMA is expressed as a percentage of these voids (asphalt and air) in between the aggregate particles divided by the total volume. In most dense asphalt mixtures the VMA will be between 12 and 16 percent.

The specifications require some minimum VMA based on the gradation of the aggregate. The smaller the maximum aggregate size used, the larger the minimum VMA will typically be. If the VMA in the mixture is too small this will result in lack of adequate space in the aggregate structure to allow for satisfactory minimum asphalt content.

3-8.8 Marshall Stability and Flow.

When the Marshall method is used to design or test mixes, the stability and flow (ASTM D 6927) are measured on compacted asphalt mixtures (4 inches in diameter) to help ensure that the overall quality of the mixture is satisfactory. The stability is the total load to failure and the flow is the deformation at failure. The stability is measured in pounds and the deformation is measured in 0.01 inches. It is important that the test be conducted at 140 degrees F which is approximately the maximum temperature that an asphalt pavement will reach during a hot summer day.

A low stability number or high flow number indicates that the asphalt mixture may not be sufficiently strong to support traffic. High stability and low flow values may indicate that the mixture is brittle which will likely result in premature cracking.

Samples of the asphalt mixture should be obtained from a loaded truck at the HMA plant and the samples should be compacted before the mix has an opportunity to cool excessively. If the mix is reheated, the binder will be stiffened and the Marshall stability will increase considerably making this a meaningless test in this case. A high percentage passing the No. 200 sieve and low asphalt content will also typically cause the mixture to have a high stability.

When using a modified asphalt the flow test results may be excessively high simply due to the flexibility of the asphalt binder. The flow value may have to be waived in this case due to these high flow numbers. This high flow number when a modified asphalt is used does not indicate that there is a mix deficiency but instead is the result of the high flexibility in the asphalt binder.

3-8.9 In-place Density (Mat).

Good compaction is essential for good performance. If the compaction is lower than desired, the life of the pavement will likely be reduced due to permeability of air and water into the mixture and oxidation of the binder.

The density is normally expressed as a percentage of the TMD but in some cases it might be expressed as a percentage of the laboratory density. Generally, the density is checked for control with a non-destructive gage such as

a nuclear density gage or a non- nuclear gage. For acceptance the density should be measured by taking cores from the in-place pavement.

Locations for cores should be selected using some type of random sample locating method. This would allow the samples to be located prior to seeing the condition of the pavement. It is not acceptable to select random samples based on visual condition of pavement. However, if there is a location that appears to be deficient, that area can be tested in addition to the lot testing but these tests cannot be included as a part of the lot evaluation. This testing of visually deficient areas should only represent those localized areas from which the samples were obtained.

3-8.10 In-place Density (Joint).

The longitudinal joints are difficult to compact and as a result this is one of the first areas that show performance problems. Since the longitudinal joints often result in performance problems, the density of the joints are obtained and evaluated separately from the mat density.

A tack coat should be applied to the edge of a constructed lane when an adjacent lane is to be placed. The purpose of this tack coat is to provide some material for sealing the joint when the adjacent lane is placed.

Cores taken for density measurement must be taken directly in the joint. On some projects these cores have been taken adjacent to the joint and not in the joint. This is not acceptable. The core size should be 4 to 6 inches in diameter. Other core sizes outside this range are not acceptable for density testing.

3-8.11 Smoothness.

Smoothness is typically measured with a 12 foot straightedge (Figure 3-51). When measuring with the straightedge, it is important to make measurements in between two points where the straightedge is touching the pavement surface or to measure an abrupt change in surface elevation at a joint for example. When there is a designed grade change, the straightedge must be used carefully. For example when measuring transversally, there are often grade changes by design at some distance from the centerline.

Measuring across the point where grade changes occur can show a gap between the straightedge and the pavement surface but this may be the result of the design not the result of construction problems. The contractor is not responsible for failure to meet the straightedge requirements when this deficiency is caused by designed grade changes.

Figure 3-51 Using Straightedge to Check Smoothness



The straightedge typically measures bumps or dips that are caused by construction issues but does not do a good job of measuring long wave length smoothness felt by aircraft or other types of vehicles. The California profilograph is used to measure this long wave length smoothness that aircraft feel. The profilograph is important to use on runways but less important on other locations on the airfield. However, meeting the straightedge requirements is important on all pavements since the pavement will tend to hold water if there is an abrupt change in elevation of the pavement surface.

3-8.12 Grade.

The grade or surface elevation needs to be controlled on some projects as designated on the plans. However, some overlay projects simply specify a certain thickness of overlay and there are no requirements for the actual surface elevation. Even if there is no elevation requirements the contractor needs to construct the project in a way that minimizes any birdbaths that might be built into the surface. Sufficient testing must be performed as the work progresses to ensure that the proper grade is obtained, or if no grade is specified, make sure that there are no areas that are low that tend to hold water.

The most common method being used to control grade is the use of stringlines. The QC should check the elevations as work progresses to ensure that everything is set up correctly and to allow modifications to be made if not set up correctly. Be careful that the stringlines do not sag in between posts that are set to the proper elevation. Generally a 25 foot spacing is used for setting the posts.

It is also important that workers do not bump the stringlines or posts resulting in a change in settings.

Other methods have been used to control grade including laser and automation along with GPS. These methods can work very well but just like with stringlines it is important that the finished elevation be checked at startup and regularly after startup to ensure that the proper grade is being constructed. When there are localized high spots these can be corrected by grinding but excessive grinding is not desirable. When there are low spots there is not a good solution other than to cut out and patch to provide the desired grade. This should only be done when one would expect the patch to be better than the existing material.

Often when grade requirements are included in the specifications, there is more than one layer being placed. This is typically a new pavement or a major rehabilitation. In many cases the contractor will do all of the grade control in the underlying layers and then place a constant thickness surface course to provide the desired grade. This will likely result in the smoothest pavement since spending a lot of effort controlling the grade of the surface may result in some loss in smoothness. It is emphasized however, that this can only be done if good grade control is provided on the base course. If not, then grade will have to be controlled on the surface. If there are deficiencies in the specified grade then the specifications identify pay reductions that should be applied.

3-8.13 QC/QA Checklist.

Things to look for during QC/QA

- 1. QC plan submitted and approved and QC plan followed**
- 2. Test results completed and reported in timely manner**
- 3. QC identifies deficiencies and documents corrective action**
- 4. Control charts plotted**
- 5. Perform sufficient QA testing to validate QC testing**
- 6. Smoothness and grade testing**
- 7. Density testing**
- 8. Laboratory validated by US Army Corps of Engineers**
- 9. Technicians and inspectors should be certified at least by the local certifying agency (typically DOT)**

3-9 PERFORMANCE PROBLEMS.

3-9.1 Introduction.

There are a number of performance problems that may occur after placing HMA mixtures. Most of these problems are due to design or construction deficiencies and can be prevented if proper procedures are used during design and construction processes. Good government oversight of construction is essential for good performance.

A description of these performance problems along with the typical causes of these problems are discussed below. Knowing the cause of problems should help to emphasize the need for good design and quality control during construction.

3-9.2 Rutting.

Rutting occurs when repeated traffic over an area results in a depression due to densification and/or shear flow of the underlying materials. The rutting can be the result of problems in the asphalt mixture (Figure 3-52) or can be caused by some problem in the underlying materials (Figure 3-53). Generally ruts that are caused from problems in underlying materials will be wider than ruts caused by asphalt mixture problems.

Figure 3-52 Mixture Rutting Caused by Asphalt Mixture Problem



Figure 3-53 Structural Rutting Caused by Problems Underneath Asphalt Mixture



Pavement design involves specifying the quality of materials, density, and thickness of layers above the subgrade so that the design traffic level can be carried successfully. If there is a structural problem this is typically caused by error in the design, failure to meet material quality requirements, deficiency in thickness, lack of compaction, and/or more traffic applied than considered during

design. It is important to ensure that all of these pavement factors are controlled during the construction process.

Deficiencies in the asphalt mixture that may lead to rutting generally include lack of good aggregate properties, wrong grade of asphalt cement, or too much asphalt cement. The biggest problems with the aggregate include use of gravels that are not very well crushed and use of too much natural sand. Gravels and natural sands tend to be rounded resulting in lack of good mixture properties. These rounded materials are often used in excess which leads to rutting in the asphalt mixture.

The grade of asphalt should be selected to perform in the climate in which it will be used. Normally performance graded (PG) asphalts are used. The upper temperature grade is selected so that the mixture will resist rutting in high temperatures for the location in which it will be used. The low temperature grade is selected so that the mixture can resist cracking during typical low temperatures for the climatic area. On many pavements especially in higher traffic areas, the high temperature asphalt binder grade is bumped (for example from 64 to 76) so that the asphalt mixture will be more resistant to rutting.

The amount of asphalt to be used in a mixture should be selected so that it provides 4% air voids in laboratory compacted samples. If more asphalt than needed is used, this will result in lower air voids in laboratory compacted samples and these mixes will tend to rut under traffic. If less asphalt than needed is used, this will likely result in durability problems. The quality of the mixture is very sensitive to the amount of asphalt.

3-9.3 Bleeding.

Bleeding (Figure 3-54) is the result of excess binder that typically migrates to the surface under traffic. In some circumstances bleeding can exist at the time compaction is completed. Bleeding generally occurs when the amount of asphalt in the mixture is too high and the in-place air voids are low. When traffic is applied to these mixtures densification occurs resulting in an over filling of the air voids and bleeding of the mixture. When bleeding occurs, there is a loss in friction resulting in an unsafe pavement. Bleeding generally occurs in areas with high traffic volumes such as roadways but can occur on airfields as well.

Figure 3-54 Bleeding of Asphalt Mixture

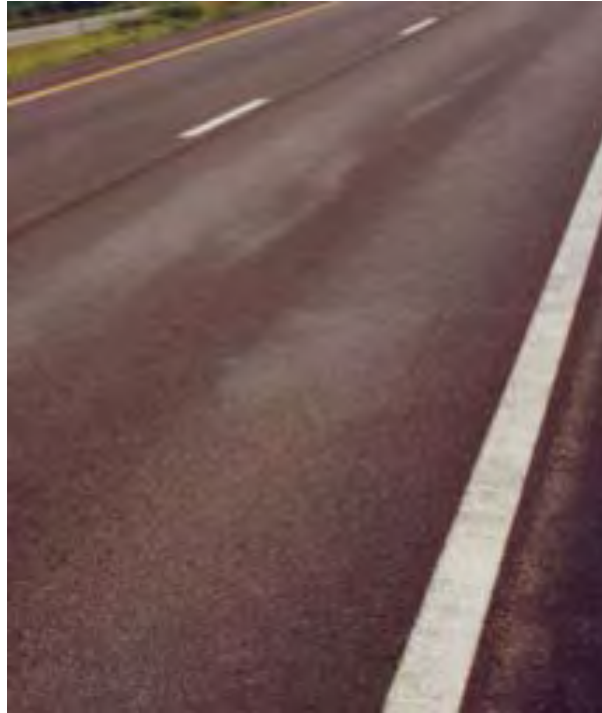

Figure 3-55 Surface Distortion



3-9.4 Surface distortion.

Traffic can cause surface distortions (Figure 3-55) to occur in asphalt mixtures especially shortly after the HMA is constructed. The asphalt mixture surface stiffens with time due to oxidation of the binder near the surface. When the mixture is new, oxidation of the binder has not occurred and the mix may tend to be tender in hot weather. This condition can be worsened when pavement sealers, such as fuel resistant sealers, are placed on a new pavement. The sealer increases the asphalt content on the surface, seals the lighter ends in the mixture, and sometimes actually softens the binder. All of these issues result in an increase in opportunity to have some surface distortions under traffic. Generally the severity of this distortion problem reduces with time as the mixture oxidizes and the surface stiffens.

3-9.5 Cracking.

There are several types of cracks that occur in an asphalt pavement. Potential types of cracks include; reflective, thermal, longitudinal, checking, slippage, alligator, and construction equipment related. The causes of each of these crack types will be discussed.

Reflective cracking (Figure 3-56) is caused when an asphalt overlay is placed over a concrete or asphalt pavement that has active cracks (the crack actually changes in width with temperature changes). The reflective cracks are caused by opening and closing of the cracks in the underlying layers as a result of temperature changes and loading. Many procedures have been tried to minimize reflective cracking but most procedures don't work very successfully. The most successful procedure when overlaying a concrete pavement is to rubblize the existing concrete. There are other procedures such as fabrics, grids, and asphalt interlayers, that may delay reflective cracking for a period of time but they do not permanently prevent the reflective crack from occurring. Making a saw cut in the asphalt over an existing joint in the concrete has been used to minimize maintenance issues.

Figure 3-56 Reflective Cracking



Thermal cracking may look similar to reflective cracking in some cases but it is caused by different issues. Thermal cracking is caused by low temperatures resulting in the shrinkage and eventual cracking of an asphalt mixture. The surface of the pavement will get colder than the underlying pavement in cold weather, hence, thermal cracking will begin at the surface and work downward. When this shrinkage is excessive during cold weather, it will cause thermal cracking to occur which will result in cracking in the pavement surface that is spaced on some typical spacing.

Longitudinal cracking can occur under traffic or in the longitudinal joints. When this type of cracking begins underneath the traffic, it is likely to eventually progress into alligator cracking since this is likely a structural issue. Cracking and raveling in longitudinal joints (Figure 3-43) is caused by lack of density in the joints and exposure to continued traffic and the environment. This longitudinal cracking may first appear similar to thermal cracking but it occurs in the longitudinal direction and it occurs in the joints since this is the weakest part of the pavement. This type of cracking can be prevented if good compaction is obtained in the longitudinal joint during construction. When this type of cracking occurs, sealing the cracks can result in increased pavement life.

Checking (Figure 3-46) often occurs during compaction of asphalt mixtures. Checking occurs when the mixture moves laterally while being rolled with steel wheel rollers during the compaction process. This type of cracking can be caused by a number of things including mix too hot, too much natural sand in mix, over rolling with steel wheel rollers, and inadequate bond to the underlying layer. Steps should be taken to minimize checking during construction. These fine cracks normally don't go very deep and generally are not a significant problem if the extent of the cracking is in a few localized areas. However, this type of cracking can lead to performance issues if steps are not taken to prevent this cracking.

Slippage cracks (Figure 3-57) result when the top layer or some other layer in the pavement slips over the underlying layer. These cracks generally are U shaped but this may be difficult to see when the width of slippage is wide (Figure 3-58). There are many causes of slippage including, improper tack coat material, improper application of tack coat, dirty tack coat, and checking or movement underneath rollers. Good oversight is needed during construction to ensure that a good tack coat is applied and the surface does not become dirty before overlay resulting in slippage.

Alligator cracking (Figure 3-59) occurs when the pavement structure is not sufficient to support the traffic. This can be the result of a number of things including quality of materials used, thickness of underlying layers, or excess moisture. Any of these problems can cause alligator cracking which is a structural problem resulting in fatigue in the asphalt mixture.

Figure 3-57 Slippage Cracks



Figure 3-58 Slippage of Asphalt Mixture over Underlying Layer



There are occasions when cracks occur as a result of marks left in the pavement from construction equipment. This can be caused by the paver or by rollers. Marks that appear to be rolled out during the rolling process can eventually result in a crack. Most often cracks from equipment occur due to a defect at the center of the paver or excessive roller marks caused by steel wheel rollers. It can also occur adjacent to paver extensions as well as at a number of other places. Make sure that the screed is placing a uniform surface without any segregation, pulling, and tearing. Make sure that excessive roller marks do not occur. Problems that adversely affect the uniformity of the HMA surface are likely to eventually result in cracking in the pavement surface.

Figure 3-59 Alligator Cracking of Asphalt Pavement



3-9.6 Raveling.

There are many times when raveling occurs in areas of segregation (Figure 3-31) or in areas with low density. The area that is most likely to have low density is in and adjacent to longitudinal joints (Figure 3-43). This raveling can be prevented during the construction process by ensuring that the pavement is uniformly placed, without segregation, and properly compacted. On an airfield any raveling can result in FOD issues.

3-9.7 Moisture Damage.

Moisture damage is a problem that many state DOTs face but this has not been a major problem on airfields. Moisture damage generally occurs when moisture susceptible aggregate is used in a mixture or when a mixture is poorly compacted after being placed. This moisture damage occurs when moisture enters the voids in the mixture and is subjected to a large number of load cycles. These cycles of traffic may result in the asphalt eventually being stripped off the mixture. Once stripping occurs, this may result in a pothole being developed or rutting (Figure 3-60) in the area of moisture damage.

The mix design includes an evaluation of the moisture susceptibility of the mixture which is the first step to ensure that moisture damage does not occur. Make sure the mixture properties are controlled during construction and good compaction is obtained. These simple steps should ensure that stripping does not occur. Also be aware that the use of diesel or other petroleum product may

cause localized stripping if these materials come in contact with the HMA. One primary source of this problem is diesel, oils, or similar materials on the pavement surface before placing the HMA. Other sources include using diesel or similar material to 1) clean out the back of trucks, 2) clean out the paver and not properly draining the excess, 3) clean small tools such as shovels etc. and 3) clean roller wheels during the compaction process.

Figure 3-60 Rutting Caused by Stripping of HMA



Figure 3-61 Block Cracking



3-9.8 Block Cracking.

Block cracking (Figure 3-61) sometimes occurs when an asphalt mixture ages and becomes brittle. As the mixture becomes more brittle cracking continues to occur resulting in the cracks becoming closer and closer together. These cracks form squares or blocks and as the cracking continues to develop the cracks may be spaced very closely together. This is more likely to happen in an area that is not exposed to very much traffic and in the southwestern part of the US where high amounts of sunlight occur. Block cracking is not a load associated problem; it is the result of aging and weathering of the asphalt mixture. The best way to minimize the potential for block cracking to occur is to ensure that the proper grade of asphalt cement is used, the asphalt mixture is not overheated during construction, and satisfactory compaction of the mixture is obtained.

3-9.9 Bibliography.

1. Brown, E. Ray, Randy Ahlrich, Ray Rollings, Steve Muench, Brian Prowell, Allen Cooley, and Robert James, "Airfield Asphalt Pavement Construction Best Practices Manual," Report Number 05-01, 2008.
2. Federal Aviation Administration, *Hot Mix Asphalt Paving Handbook*, AC 150/5370-14A Appendix 1, 2000.
3. NAPA Research and Education Foundation, *Hot Mix Asphalt Materials, Mixture Design, and Construction*, Brown, E. R., P. S. Kandhal, F. L. Roberts, Richard Kim, D. Y. Lee, and T. W. Kennedy, 3rd edition, Lanham, MD, 2009.

CHAPTER 4 PORTLAND CEMENT CONCRETE

4-1 SUBMITTALS.

4-1.1 Requirements.

The submittal requirements are summarized in the following paragraphs. Guidance on government review of each submittal is provided in the following chapters of this manual.

4-1.1.1 Equipment:

- Details and data on the batching and mixing plant prior to plant assembly including manufacturer's literature showing that the equipment meets all requirements specified herein.
- Certified copy of the NRMCA QC Manual Section 3 Concrete Plant Certification Checklist and Calibration documentation on all measuring and weighing devices, submitted prior to uniformity testing.
- Description of the equipment proposed for transporting concrete mixture from the central mixing plant to the paving equipment.
- Description of the equipment proposed for the machine and hand placing, consolidating and curing of the concrete mixture. Manufacturer's literature on the paver and finisher, together with the manufacturer's written instructions on adjustments and operating procedures necessary to assure a tight, smooth surface on the concrete pavement. The literature shall show that the equipment meets all details of these specifications.

4-1.1.2 Construction Techniques:

- Pavement demolition work plan, presenting the proposed methods and equipment to remove existing pavement and protect pavement to remain in place
- Description of the placing and protection methods proposed when concrete is to be placed in or exposed to hot, cold, or rainy weather conditions.
- Detailed paving sequence plan and proposed paving pattern showing all planned construction joints; transverse and longitudinal dowel bar spacing; and identifying pilot lanes and hand placement areas.
- Data on the curing equipment, media and methods to be used.
- Plan and equipment proposed to control alignment of sawn joints within the specified tolerances.
- Data on profilograph and methods to measure pavement smoothness.
- Pavement diamond grinding equipment and procedures.

4-1.1.3 Mix Proportioning:

- The results of the mixture proportioning studies shall include a statement giving the maximum nominal coarse aggregate size and the weights and volumes of each ingredient proportioned on a one cubic yard basis. The recommended mixture proportions shall be accompanied by test results demonstrating that the proportions selected will produce concrete of the qualities indicated.
- Certified copies of laboratory test reports and sources for cement, supplementary cementitious materials (SCM), aggregates, admixtures, curing compound, epoxy, and proprietary patching materials proposed for use on this project. All aggregate tests shall have been performed no earlier than 6 months prior to contract award.

4-1.1.4 Personnel and Laboratory Facilities:

- American Concrete Institute certification for Contractor Quality Control staff.
- Qualifications and resumes for petrographer, surveyor, concrete batch plant operator, and profilograph operator.
- Accreditation of the commercial laboratory by an independent evaluation authority, indicating conformance to ASTM C 1077, including all applicable test procedures.
- USACE validation letter for commercial laboratory.

4-2 LABORATORY COMPLIANCE.

4-2.1 Accreditation and Certification

Accreditation can be verified by reviewing the accredited laboratories category on the accrediting agency's website. An example of a print out from the ERDC MTC website is presented below as Figure 4-1.

Concrete technicians are certified by local chapters of the American Concrete Institute (ACI) located at http://www.concrete.org/certification/cert_prog.asp. The following grades of technician certification are required:

- Concrete Transportation Inspector - personnel responsible for inspection of concrete paving operations
- Concrete Flatwork Technician/Finisher - lead foreman or journeyman of the concrete placing, finishing and curing crews
- Concrete Field Testing Technician, Grade I - field testing technicians
- Concrete Strength Testing Technician or Laboratory Testing Technician, Grade I or II - laboratory testing technicians.

- Trained in petrographic examination of concrete aggregate according to ASTM C 294 and ASTM C 295
- Trained in identification of the specific deleterious materials and tests identified in this specification.

The petrographer's resume shall detail the education, training and experience related to the project-specific test methods and deleterious materials and shall be submitted to the USACE Transportation Systems Center (TSMCX) or ERDC-MTC at least 20 days before petrographic and deleterious materials examination is to commence.

4-2.2 USACE Validation.

For projects managed by the U.S. Army Corps of Engineers (USACE), validation of the laboratory is required. This validation is performed by ERDC-MTC. The validation process ranges from a desk audit of the accrediting agency's documentation for an accredited laboratory to a full scope inspection/accreditation for an unaccredited laboratory. This validation is performed at the Contractor's expense and should be performed prior to initiating any concrete materials sampling or testing.

4-2.3 Compliance Checklist.

- Must meet all of the requirements of Section 2-1.
- ACI concrete technician certificates are current and the appropriate level of expertise
- Forward petrographer's resume to TSMCX or ERDC-MTC

4-3 MATERIALS.

4-3.1 Introduction.

Portland cement concrete (PCC) is composed of hydraulic cement, aggregates, water, and chemical admixtures. The typical sequence in the development of the PCC mix design is for the Contractor to select his materials, perform laboratory testing to document that the materials comply with the specification requirements, and then incorporate the materials into the mix proportioning process. This section provides guidance on materials selection and testing and Government QA of the results. Section 4-4 provides guidance on developing and reviewing the mix design.

4-3.2 Cementitious Materials.

4-3.2.1 Portland Cement. Portland cement is specified in accordance with ASTM C 150, as follows:

- Type 1 - general use
- Type II - moderate sulfate resistance or moderate heat of hydration
- Type III - high early strength
- Type IV - low heat of hydration (for mass concrete, not pavements)
- Type V - high sulfate resistance

Typically, the specifications require Type I or II Portland cement. Type III is more costly and generates more heat of hydration, leading to potential shrinkage cracking. The use of this type is reserved for relatively small placements, where time is a premium. Type V cement is required where high-level sulfate-bearing soils or ground water have been identified. The low alkali requirement (equivalent alkalis < 0.60%) is required if the proposed aggregates are found to have greater than 0.04% expansion when tested in accordance with ASTM C 1260.

Portland cement is accepted on the basis of a mill certificate produced by the cement manufacturer. Third-party, independent testing is not required unless poor performance is observed. A typical mill certificate is presented on Figure 4-2.

4-3.2.2 Blended Cement. Blended cement is specified for U.S. Army and U.S. Air Force projects only. The U.S. Navy does not permit their use. Blended cement is specified in accordance with ASTM C 595. The UFGS restricts the choice of blended cement options available in C 595 to two:

- Type IP – Portland cement blended with 15-40% pozzolan
- Type IS – Portland cement blended with 25-70% granulated blast furnace slag

Note that a wide range in pozzolan or blast furnace slag composition is available to the manufacturers. The percentage and type of mineral admixture used in the blend shall not change from that submitted for the aggregate evaluation and mixture proportioning.

Blended cement is accepted on the basis of a mill certificate produced by the cement manufacturer.

4-3.2.3 Supplementary Cementitious Materials (SCM).

Supplementary cementitious materials (SCM), such as fly ash, pozzolans, ground granulated blast furnace slag (GGBFS), or Silica Fume (for OCONUS projects only), may be added to mitigate aggregate-cement Alkali Silica Reactivity (ASR), decrease permeability, or increase strength. The use of a SCM

is required by the U.S. Navy, but is a Contractor's option for U.S. Army and U.S. Air Force projects, unless required to mitigate ASR.

A pozzolan is a siliceous or siliceous and aluminous material which in itself possesses little or no cementitious value but will, in finely divided form and in the presence of moisture, chemically react with calcium hydroxide to form compounds possessing cementitious properties. Pozzolan is specified in accordance with ASTM C 618 and consists of one class, N. Class N pozzolan consists of raw or calcined (heated to high temperature) diatomaceous earth, opaline cherts, shales, tuffs and volcanic ashes.

Fly ash is a finely divided residue that results from the combustion of ground or powdered coal and is collected in the flue stack baghouse. It is not the same as incinerator ash produced from municipal or industrial waste disposal operations. Fly ash is specified in accordance with ASTM C 618 and consists of two classes: Class F and Class C. The class of the fly ash is determined by the coal source. Class F fly ash is produced from anthracite or bituminous coal and Class C fly ash is produced from lignite or subbituminous coal. Only Class F fly ash is permitted for use in DOD airfield pavements, because Class C fly ash can aggravate ASR. Fly ash is accepted on the basis of test results provided by an independent, commercial laboratory, since most power plants do not have the laboratory testing capability. A typical report of testing results for a Class F fly ash is presented on Figure 4-2.

Ground Granulated Blast Furnace Slag (GGBFS) is produced when molten blast furnace slag is rapidly chilled by immersion in water, then ground to cement fineness. GGBFS is specified in accordance with ASTM C 989 and consists of three grades. The UFGS restricts the choice of blended cement options available in C 989 to two:

- Grade 100 – 28-day strength = 95% of a Portland cement mix
- Grade 120 – 28 day strength = 115% of a Portland cement mix

Silica Fume is a very fine pozzolanic material, composed mostly of amorphous silica produced by electric arc furnaces as a byproduct of the production of elemental silicon or ferro-silicon alloys. Silica Fume is specified in accordance with ASTM C 1240. This SCM is permitted only in OCONUS projects, where more economical fly ash, pozzolan, or GGBFS are not available. Handling, storing, and batching Silica Fume are problematic and require the assistance of a qualified manufacturer's representative.

Figure 4-2 Certified Test Results for Class F Fly Ash1



RESOURCE MATERIALS TESTING, INC.
 "Specialists in Fly Ash Testing"

P.O. Box 1335 -- Murphy NC 28906 1-877-217-5147

REPORT OF FLY ASH ANALYSIS

TO: Phoenix Cement Company
 Attn: Mr Dale Diulus, P.E.
 8800 E Chaparral Road, Suite 155
 Scottsdale, AZ 85250-2618

PROJECT NO.: RMT-310
 SAMPLE NO.: 11467
 DATE RECEIVED: 11-29-00
 DATE REPORTED: 01-07-01

PROJECT NAME: Four Corners Plant Fly Ash Quality Assurance Program
 SAMPLE ID: Class F Fly Ash Lot # 5304

| CHEMICAL ANALYSIS: | RESULTS | ASTM C-618 SPEC. F/C |
|-----------------------------------------------------------------------------------------------|---------|----------------------|
| Silicon Dioxide, SiO ₂ , % | 59.92 | — |
| Aluminum Oxide, Al ₂ O ₃ , % | 26.08 | — |
| Iron Oxide, Fe ₂ O ₃ , % | 5.12 | — |
| Sum of SiO ₂ , Al ₂ O ₃ & Fe ₂ O ₃ , % | 91.12 | 70/50 Min |
| Calcium Oxide, CaO, % | 2.23 | — |
| Magnesium Oxide, MgO, % | 1.28 | — |
| Sodium Oxide, Na ₂ O, % | 1.89 | — |
| Potassium Oxide, K ₂ O, % | 1.09 | — |
| Sulfur Trioxide, SO ₃ , % | 0.39 | 5.0 Max |
| Moisture Content, % | 0.34 | 3.0 Max |
| Loss on Ignition, % | 0.71 | 6.0 Max |
| Available Alkalies as Na ₂ O, %* | 0.89 | 1.5 Max |
| PHYSICAL ANALYSIS: | | |
| Amount Retained on No. 325 Sieve, % | 16.0 | 34 Max |
| Strength Activity Index** | 86 | 75 Min |
| Portland Cement @ 7 days, % of Control | 87 | 75 Min |
| Portland Cement @ 28 days, % of Control | 98 | 105 Max |
| Water Requirement, % of Control | -0.02 | 0.8 Max |
| Autoclave Expansion, % | 2.05 | — |
| Specific Gravity | — | 0.03 Max |
| Increase of Drying Shrinkage, %* | — | — |
| Reactivity with Cement Alkalies, %* | 65 | — |
| Reduction of Mortar Expansion, % | 21 | 100 Max |
| Mortar Expansion, % of LA Tijeras Control | — | — |
| Air Entrainment of Mortar, % | — | — |

* Optional requirements applicable only when requested by purchaser. This material meets the requirements of ASTM C 618 for the parameters tested.

By *Robert L. Smith*
Robert L. Smith, Ph.D.

4-3.3 Aggregates.

The quality and gradation of aggregates are important to the strength and durability of concrete because they occupy about 75 percent of the volume. Aggregates used in airfield pavement PCC are more critical than those used in

highway PCC because of: 1) significantly higher wheel loads, and 2) impact costs when repairs are required.

4-3.3.1 Coarse Aggregates. Coarse aggregate shall consist of crushed or uncrushed gravel, crushed stone, or a combination thereof. Coarse aggregate shall have a satisfactory service record in freezing and thawing of at least 5 years successful service in three concrete paving projects. Aggregate not having a satisfactory demonstrable service record shall have a durability factor of 50 or more when subjected to freezing and thawing of specimens prepared in accordance with ASTM C 1646/C 1646M and tested in accordance with <RID>ASTM C 666/C 666M, Procedure A.

NOTE: The service record shall include a condition survey of the existing concrete and a review of the concrete-making materials, including coarse and fine aggregates, cement, and mineral admixtures. This review should consider the previous aggregate source and test results, cement mill certificate data, mineral admixture chemical and physical composition, and the mix design (cement factor and water-cementitious material ratio).

Testing is required to document the quality of the aggregate source. All aggregate testing shall be performed no earlier than six months prior to contact award. Historical results are not acceptable. Aggregate quality tests are required for the following properties:

- Los Angeles Abrasion resistance, ASTM C 131
- Sulfate Soundness, ASTM C 88
- Flat and Elongated Pieces, ASTM D 4971
- Alkali-Silica Reactivity, ASTM C 1260 and C 1567
- Accelerated Alkali-Silica Reactivity, Innovative Pavement Research Foundation (IPRF) Interim Test Protocol (for airfields using chemical pavement deicing compounds)
- Deleterious Materials, UFGS-specified six-step procedure

The evaluation of ASR potential is a two-step process:

- Evaluate the individual aggregate sources in accordance with ASTM C 1260, using an expansion criterion of less than/equal to 0.08 percent after 28-days of immersion.
- If the aggregates exceed this expansion percentage, incorporate low-alkali cement, SCM, or Lithium Nitrate and evaluate the expansion of the combination in accordance with ASTM C 1567. The quantity of SCM shall be in accordance with the specification provisions.

NOTE: Contact the TSCMX, NAVFAC or Air Force MAJCOM pavement engineers before specifying Lithium Nitrate to mitigate Aggregate-Silica Reaction (ASR). Coordinate with manufacturer regarding Lithium Nitrate dosage.

If any of the above options does not lower the expansion to less than 0.08 percent after 28 days of immersion, the aggregate(s) shall be rejected and the Contractor shall submit new aggregate sources for retesting.

Mixture proportioning shall be based on the highest percentage of SCM required to mitigate ASR-reactivity, as determined from either test series.

The testing sequence for coarse aggregate deleterious materials is specified in the UFGS. This sequence must be followed in the order specified, since various deleterious materials are removed after identification in the testing sequence. The identification of clay ironstone, chert and cherty stone, claystone, mudstone, siltstone, and shaly and argillaceous limestone must be performed by an approved petrographer.

NOTE: Sample size is significant to the test results because of the low limits permitted on each deleterious material. The size of the coarse aggregate sample shall be at least 200 pounds for the 3/4 inch and larger maximum size, 25 pounds for the No. 4 to 3/4 inch coarse aggregate, and 10 pounds for the fine aggregate.

4-3.3.2 Fine Aggregate. Fine aggregate shall consist of natural sand, manufactured sand, or a combination of the two, and shall be composed of clean, hard, durable particles meeting the requirements of ASTM C 33.

Testing is required to document the quality of the fine aggregate source. All aggregate testing shall be performed no earlier than six months prior to contract award. Historical results are not acceptable. Aggregate quality tests are required for the following properties:

- Clay Lumps and Friable Particles, ASTM C142
- Material Finer than No. 200 sieve, ASTM C 117
- Lightweight Particles (Specific Gravity 2.0 or less), ASTM C 123

4-3.3.3 Aggregate Gradation. Gradation testing shall be performed on each coarse and fine aggregate source in accordance with ASTM C 117 and C 136. Testing for absorption and specific gravity shall also be performed in accordance with ASTM C 127 and C 128.

Grading of the fine aggregate, as delivered to the mixer, shall conform to the requirements of ASTM C 33 and shall have a fineness modulus (FM) of not less

than 2.50 or more than 3.00. The FM is a measure of the fine aggregate's coarseness, with a higher value representing a coarser gradation.

The nominal maximum size of the coarse aggregate shall be 1.5 inches. For Army projects, coarse aggregates greater than 1 inch in nominal maximum size shall be graded and furnished in two size groups meeting the individual grading requirements of ASTM C 33, Size No. 4 (1.5 to 0.75 inches) and Size No. 67 (0.75 inches to No. 4). For Air Force and Navy, projects, the individual aggregates shall be graded and furnished in size groups to meet the coarseness and workability factors criteria for the contractor-proposed combined gradation. The coarseness and workability factor calculations are discussed in Section 4-4.

4-3.4 Chemical Admixtures.

Chemical admixtures are added to a concrete mixture for the purpose of achieving a specific modification to the normal properties of concrete. These materials are generally added as a liquid into the concrete mixing drum. Non-chloride containing admixtures are required, since chloride in the concrete can corrode embedded steel or reinforcement. Certified test results are required for acceptance.

4-3.4.1 Air Entraining Admixture. An air entraining admixture (AEA) is added to concrete to provide resistance to freeze and thaw conditions. Air entraining admixtures are specified in accordance with ASTM C 260.

NOTE: Airfield pavement PCC is required for hangar floor slabs. Many dry shake finishes for hangar floors require non-air entrained PCC to permit working the dry shake into the PCC surface. In this case, follow the dry-shake manufacturer's recommendations.

4-3.4.2 Water Reducers, Retarders and Accelerators. Water reducers, retarders, accelerators and combinations are specified in accordance with ASTM C 494. The terms "retarder" and "accelerator" may be confusing. Neither of these materials retard or accelerate the rate of strength gain or the ultimate strength, they only retard or accelerate the time to early and final set. A retarder is typically used in hot weather conditions to extend the setting time, while an accelerator is typically used in cold weather to shorten the setting time.

There are seven admixtures specified in ASTM C 494:

- Type A – water-reducing admixture
- Type B – retarding admixture
- Type C – accelerating admixtures
- Type D – combination water-reducing and retarding admixture
- Type E – combination water-reducing and accelerating admixture
- Type F – high range water-reducing admixture

- Type G – combination high range water-reducing and retarding admixture

Types F and G high range water reducing admixtures and admixtures producing flowing concrete (ASTM C 1017) are not permitted in airfield pavement concrete, except as noted below.

4-3.4.3 Lithium Nitrate. Lithium Nitrate (LiNO) is a chemical admixture added to mitigate ASR. The lithium admixture shall be a nominal 30 percent aqueous solution of Lithium Nitrate, with a density of 10 pounds/gallon, and shall have the approximate chemical form as shown in Table 4.1

Table 4.1 Lithium Nitrate Composition

| Constituent | Limit (% by Mass) |
|------------------------|--------------------------|
| LiNo (Lithium Nitrate) | 30 +/- 0.5 |
| SO (Sulfate Ion) | 0.1 (max) |
| Cl (Chloride Ion) | 0.2 (max) |
| Na (Sodium Ion) | 0.1 (max) |
| K (Potassium Ion) | 0.1 (max) |

NOTE: Contact the TSCMX, NAVFAC or Air Force MAJCOM pavement engineers before specifying Lithium Nitrate to mitigate Aggregate-Silica Reaction (ASR). Coordinate with manufacturer regarding Lithium Nitrate dosage.

4-3.4.4 High-Range Water-Reducing Admixtures. A high-range water-reducing admixture (HRWRA) shall meet the requirements of ASTM C 494, Type F or G. The HRWRA shall be free from chlorides, alkalis, and shall be of the synthesized, sulfonated complex polymer type. The HRWRA shall be added to the concrete as a single component at the batch plant. The admixture shall be added to the concrete mixture only when its use is approved or directed, and only when it has been used in mixture proportioning studies to arrive at approved mixture proportions.

NOTE: HRWRA are permitted only when used with Silica Fume in order to mitigate the water demand of the Silica Fume. These projects are limited to OCONUS, where other SCM are not available.

4-3.5 Water.

Water for mixing and curing PCC shall be fresh, clean, potable, and free of injurious amounts of oil, acid, salt, or alkali, except that non-potable water, or water from concrete production operations, may be used if it meets the requirements of ASTM C 1602.

4-3.6 Other Materials.

Materials required for PCC airfield pavement construction, but not used in the production of the PCC, include:

- Expansion and slip joint materials
- Bar mat reinforcement and welded wire fabric
- Dowel bars and baskets
- Epoxy resin

The requirements for these materials are specified in the UFGS.

4-3.7 Compliance Checklist.

- Portland Cement:
 - Type as specified
 - Low Alkali included
 - Mill certificate furnished
 - Date is current
 - Lot number provided and matches mix design documentation
 - Physical and chemical results reported
- Blended Cement:
 - Type as specified
 - Amount of pozzolan or slag additive is provided
 - Mill certificate furnished
 - Date is current
 - Lot number provided and matches mix design documentation
 - Physical and chemical results reported
- Supplementary Cementitious Materials:
 - Class F Fly ash, Class N pozzolan, or Grade 100/120 GGBFS, provided
 - Test results furnished
 - Date is current
 - Lot number provided and matches mix design documentation
 - Physical and chemical results reported
- Aggregates:
 - Test results furnished for each aggregate size and source
 - Date is current
 - Individual gradations, absorptions and specific gravities reported
 - Quality data reported
 - Coarse aggregate deleterious results performed/reported in accordance with specification protocol
 - Freeze-thaw results or service record provided
- Chemical Admixtures:
 - Certified test results provided for each admixture
 - Manufacturer's certification stating no chloride ions in product
 - Date is current
- Water:
 - Potable source identified
 - Test results if non-potable source proposed
- Other Materials:
 - Test results in accordance with specification requirements

4-4. MIX PROPORTIONING.

4-4.1 Introduction.

After test results have demonstrated the Contractor's proposed materials are in accordance with the specification provisions, mix proportioning may proceed. The mix proportioning method shall be the trial batch method outlined in ACI 211.1.

4-4.2 Design Criteria.

The mix proportioning shall be designed to meet the following criteria:

- Flexural strength (R_{90}) – typically 650 psi at 90-days of age, check specifications.
- Water-cementitious materials ratio (WCR) – 0.45 maximum
- Cementitious materials content:
 - Straight Portland cement – 470 pounds per cubic yard
 - Cementitious blends – 517 pounds per cubic yard
- Air content – depends on freeze-thaw environment, check specifications
- Slump:
 - For slipform placement – selected by Contractor
 - For fixed form placement – 2 inches maximum
- Aggregate gradation – combined gradation (for Air Force and Navy projects)

4-4.3 Aggregate Blending.

The combined gradation requirement is intended to produce a well-graded aggregate skeleton that minimizes the amount of paste (cementitious materials and fine aggregate), and leads to a more economical mixture with less shrinkage potential. This gradation is determined by mathematically combining the individual aggregate gradations based on their proposed percentages. Once the combined gradation is determined, two factors can be calculated:

- The Coarseness Factor (CF), defined as:

$$CF = \frac{\text{cumulative percent **retained** on the } 3/8 \text{ inch sieve (100\%)}}{\text{cumulative percent **retained** on the No. 8 sieve}}$$

- The Workability Factor (WF) is defined as:

$$WF = \text{percent **passing** the No. 8 sieve}$$

The WF shall be adjusted, upwards only, by 2.5 percentage points for each 94 pounds of cementitious material per cubic yard greater than 564 pounds per cubic yard.

An example of this calculation is presented on Figure 4-3.

Figure 4-3 Combined Gradation Calculation and Determination of CF and WF1

| Sieve size | Percent Passing | | | | | | combined gradation | | combined individual gradation |
|------------|----------------------------------------------|--|-------------------------------------------|--|----------------------------------------------|--|---------------------|----------------------|-------------------------------|
| | # 67 MM | | #4 MM | | sand | | % passing by weight | % retained by weight | |
| | 1,750 lbs 54.3% 8.40 cf Sp.Gr. 2.68 | | 200 lbs 6.2% 3.30 cf Sp.Gr. 2.67 | | 1,270 lbs 39.4% 7.71 cf Sp.Gr. 2.62 | | | | |
| 2 in | 100.0 | | 100.0 | | 100.0 | | 100.0 | 0.0 | 0.0 |
| 1 1/2 in | 100.0 | | 96.0 | | 100.0 | | 99.8 | 0.2 | 0.2 |
| 1 in | 100.0 | | 24.0 | | 100.0 | | 95.3 | 4.7 | 4.5 |
| 3/4 in | 91.0 | | 4.0 | | 100.0 | | 89.1 | 10.9 | 6.1 |
| 1/2 in | 39.0 | | 2.2 | | 100.0 | | 60.8 | 39.2 | 28.4 |
| 3/8 in | 23.0 | | 1.0 | | 100.0 | | 52.0 | 48.0 | 8.8 |
| No. 4 | 6.0 | | 0.8 | | 96.0 | | 41.2 | 58.8 | 10.8 |
| No. 8 | 3.0 | | 0.8 | | 90.0 | | 37.2 | 62.8 | 4.0 |
| No. 16 | 1.9 | | 0.4 | | 82.0 | | 33.4 | 66.6 | 3.8 |
| No. 30 | 1.7 | | 0.4 | | 60.0 | | 24.6 | 75.4 | 8.8 |
| No. 50 | 1.0 | | 0.4 | | 15.0 | | 6.5 | 93.5 | 18.1 |
| No. 100 | 0.6 | | 0.4 | | 1.0 | | 0.7 | 99.3 | 5.7 |
| No. 200 | 0.4 | | 0.4 | | 0.3 | | 0.4 | 99.6 | 0.4 |

Example Calculation for No. 4 sieve:
 $\% \text{ Passing} = .543 \times 6.0\% + 0.062 \times 0.8\% + .394 \times 96.0\% = 41.2\%$

CF = 76.4
 WF = 37.2

The CF and WF are plotted on a diagram using a rectangular scale with WF on the Y-axis with units from 20 (bottom) to 45 (top), and with CF on the X-axis with units from 80 (left side) to 30 (right side). On this diagram a parallelogram shall be plotted with corners at the following coordinates (CF-75, WF-28), (CF-75, WF-40), (CF-45, WF-32.5), and (CF-45, WF-44.5). An example of this diagram is presented on Figure 4-4.

The point determined from the CF and WF calculated from the combined gradation shall plot within the limits of the parallelogram. As a secondary criteria, but not part of the UFGS requirement, the point should be within the shaded areas, which are optimized for the various concrete placement methods.

Figure 4-4 CF and WF Plot

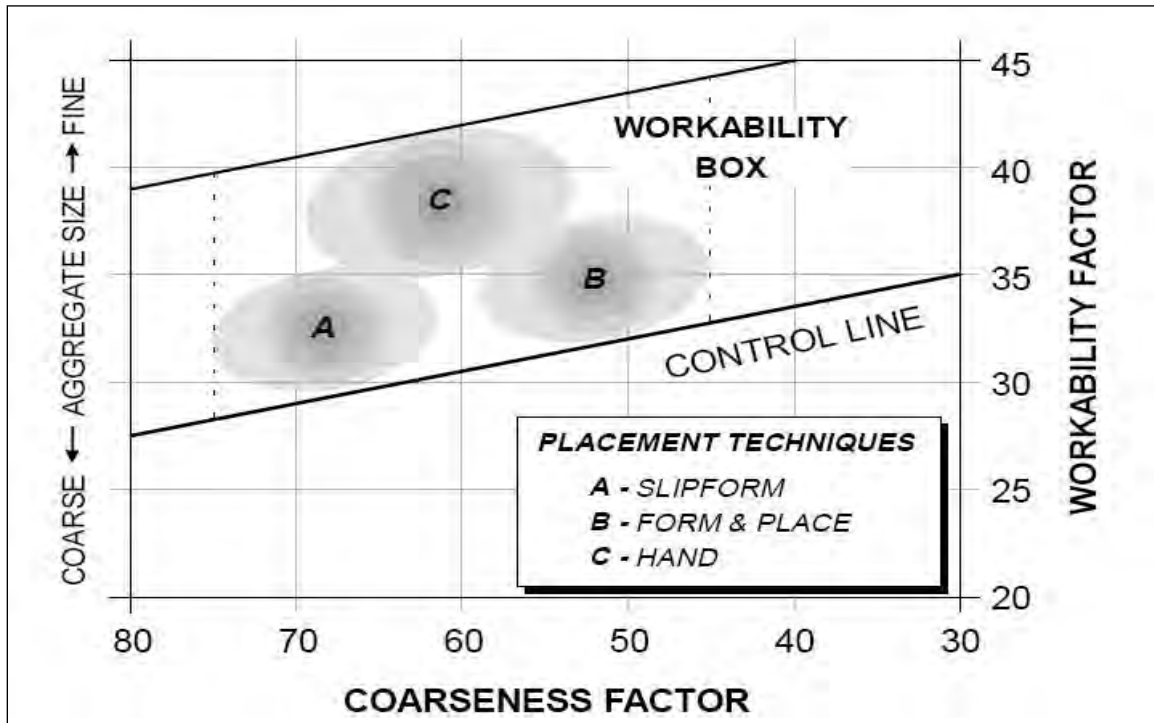

NOTE: No single combined gradation is best for the various placement conditions that may be anticipated. Several combined gradations may need to be developed for use during the placement operations.

4-4.4 Trial Batches.

At least three different water-cement ratios, which will produce a range of strength encompassing that required on the project, shall be used. The maximum allowable water-cement ratio permitted is 0.45. Laboratory trial mixtures shall be proportioned for maximum permitted slump and air content.

Separate sets of trial mixture studies shall be made for each combination of cementitious materials and each combination of admixtures proposed for use. No combination of either shall be used until proven by such studies, except that, if approved in writing and otherwise permitted by these specifications, an accelerator or a retarder may be used without separate trial mixture study. Separate trial mixture studies shall also be made for concrete for each placing

method proposed. The temperature of concrete in each trial batch shall be reported. Each mixture shall be designed to promote easy and suitable concrete placement, consolidation and finishing, and to prevent segregation and excessive bleeding.

Flexural strength is based on beams cast and cured in accordance with ASTM C 192 and tested in accordance with ASTM C 78. The specifications permit one of two options: 1) using beams for QC control and QA acceptance, or 2) using 6-inch by 12-inch compressive cylinders cast and cured in accordance with ASTM C 192 and tested in accordance with ASTM C 39, correlated to corresponding flexural beams.

The UFGS specifications contain payment reduction factors for pavement thickness, smoothness and grade. However, there is no payment reduction for flexural strength lower than specified. The only alternative is to remove and replace the impacted lot of material. To counter this impact, the specifications require that the selection of the design WCR be based on an increased R_{90} , i.e., $R_a = R_{90} \times \text{strength increase factor}$. The specifications permit three options to determine the strength increase factor:

- Previous test results, with a minimum of 30 consecutive tests
- Previous test results, with 15-29 consecutive tests
- No previous test results

The Contractor shall submit documentation if he proposes to base the strength increase factor on previous test results. Where a concrete production facility has previous test records current to within 18 months, a standard deviation shall be established in accordance with the applicable provisions of ACI 214.3R. Test records from which a standard deviation is calculated shall represent materials, quality control procedures, and conditions similar to those expected, shall represent concrete produced to meet a specified flexural strength or strengths within 150 psi of the 90-day flexural strength specified for the proposed work, and shall consist of at least 30 consecutive tests. The required average flexural strength, R_a is calculated from the standard deviation, S , using the equation: $R_a = R_{90} + 1.34S \times \text{modification factor}$. The modification factor varies from 1.16 (for 15 tests) to 1.0 (for 30 tests) and is tabulated in the specifications.

NOTE: For most projects, these records are most likely not available, since most concrete suppliers do not produce a mix with 1 1/2-inch maximum size aggregate and low slump. When a concrete production facility does not have sufficient field strength test records for calculation of the standard deviation, the required average strength, R_a , shall be determined by adding 15 percent to the specified flexural strength, R_{90} .

A step-by-step procedure for selecting the design WCR and correlation ratios based on flexural beams consists of:

- Fabricate all beams for each mixture from the same batch or blend of batches.
- Fabricate and cure all beams in accordance with ASTM C 192, using 6 x 6 inch steel beam forms.
- Cure test beams from each mixture for 3, 7, 14, and 90-day flexural tests; 6 beams to be tested per age.
- Test beams in accordance with ASTM C 78
- Using the average strength for each w/c at each age, plot all results from each of the three mixtures on separate graphs for w/c versus: 3-day, 7-day, 14-day, and 90-day flexural strength
- From these graphs select a WCR that will produce a mixture giving a 90-day flexural strength equal to R_a
- Using the above selected WCR, select from the graphs the expected 3, 7 and 14-day flexural strengths.
- From the above expected strengths for the selected mixture, determine the Ratio of the 7-day flexural strength of the selected mixture to the 90-day flexural strength of the mixture (for CQC control).
- From the above expected strengths for the selected mixture, determine the Ratio of the 14-day flexural strength of the selected mixture to the 90-day flexural strength of the mixture (for acceptance).

A step-by step procedure for selecting the design WCR and correlation ratios based on flexural beams and compressive cylinders consists of:

- Fabricate all beams and cylinders for each mixture from the same batch or blend of batches. Fabricate and cure all beams and cylinders in accordance with ASTM C 192, using 6 x 6 inch steel beam forms and 6 x 12 inch single-use cylinder forms.
- Cure test beams from each mixture for 3, 7, 14, and 90-day flexural tests; 6 beams to be tested per age.
- Cure test cylinders from each mixture for 3, 7, 14, and 90-day compressive strength tests; 6 cylinders to be tested per age.
- Test beams in accordance with ASTM C 78, cylinders in accordance with ASTM C 39.
- Using the average strength for each w/c at each age, plot all results from each of the three mixtures on separate graphs for w/c versus:
 - 3-day, 7-day, 14-day, and 90-day flexural strength
 - 3-day, 7-day, 14-day, and 90-day compressive strength
- From these graphs select a WCR that will produce a mixture giving a 90-day flexural strength equal to R_a .

- Using the above selected WCR, select from the graphs the expected 3, 7, 14, and 90-day flexural strengths and the expected 3, 7, 14, and 90-day compressive strengths for the mixture.
- From the above expected strengths for the selected mixture determine the following Correlation Ratios:
 - Ratio of the 14-day compressive strength of the selected mixture to the 90-day flexural strength of the mixture (for acceptance).
 - Ratio of the 7-day compressive strength of the selected mixture to the 90-day flexural strength of the mixture (for CQC control).

If there is a change in materials, additional mixture design studies shall be made using the new materials and new Correlation Ratios shall be determined. No concrete pavement shall be placed until the Contracting Officer has approved the Contractor's mixture proportions. The approved WCR shall not exceed 0.45.

An example of data presentation format for a single WCR is shown on Figure 4-5.

Figure 4-5 Typical Data Presentation for a Single WCR

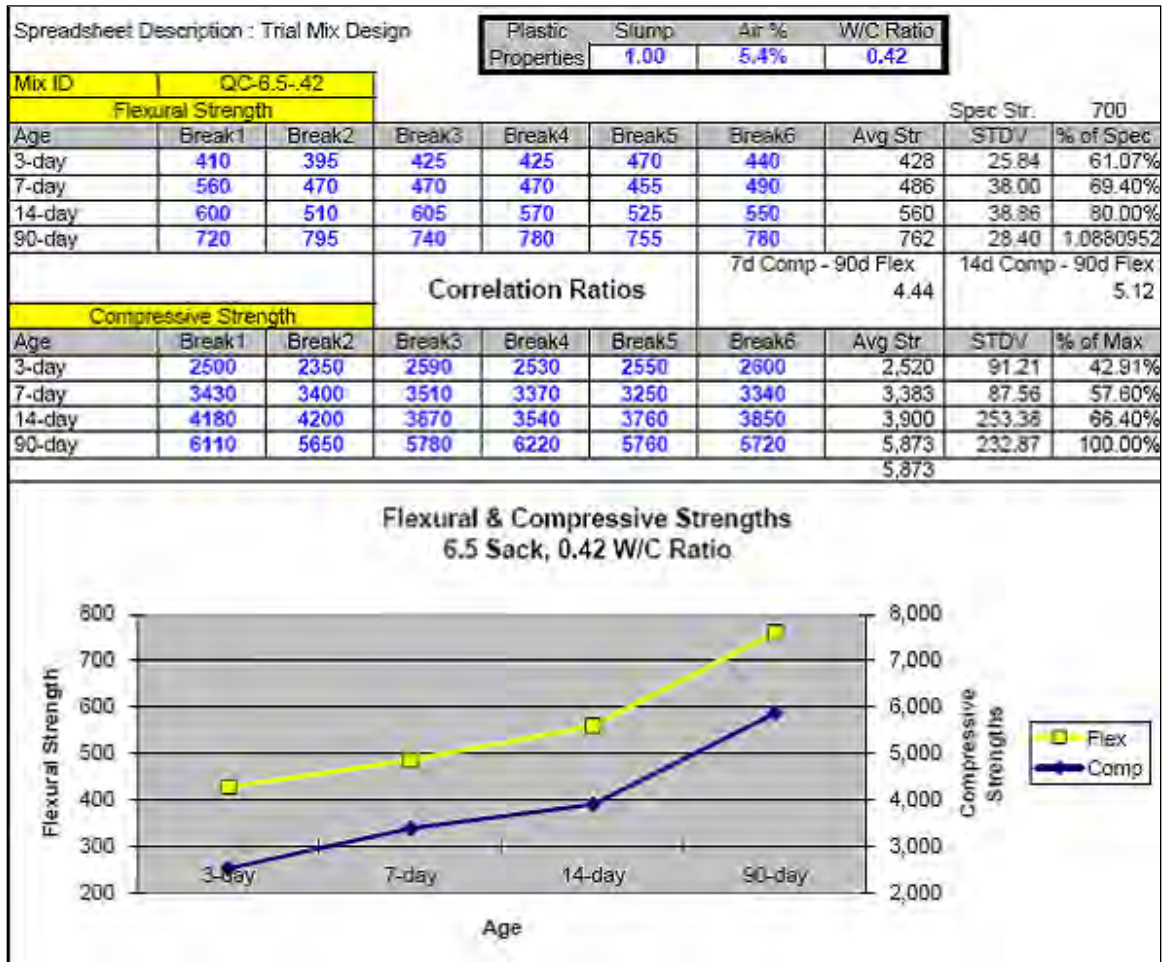

An example of a mix proportioning study summary is presented on Figure 4-6.

Figure 4-6 Mix Proportioning Study Summary

| MIX PROPORTIONING STUDIES | | | | | | |
|---------------------------------------------------|------------------------------------|----------|----------|----------|----------|----------|
| DESIGN/BUILD REPLACE AIRFIELD RAMP - KIRTLAND AFB | | | | | | |
| Design | 26-.4 | 26-.45 | 26-.5 | 27-.4 | 27-0.45 | 27-.5 |
| Batch Date | 10/13/00 | 10/03/00 | 10/11/00 | 10/13/00 | 10/16/00 | 10/16/00 |
| w/c ratio | 0.4 | 0.45 | 0.5 | 0.4 | 0.45 | 0.5 |
| Mix Proportions (pcy) | | | | | | |
| Cement | 433 | 388 | 347 | 461 | 410 | 369 |
| Fly ash | 144 | 129 | 116 | 154 | 137 | 123 |
| Blended Sand | 1401 | 1525 | 1587 | 1345 | 1452 | 1540 |
| Size #4 aggregates | 323 | 319 | 306 | 334 | 324 | 316 |
| Size #67 aggregates | 1237 | 1222 | 1173 | 1253 | 1218 | 1188 |
| Water | 231 | 230 | 231 | 246 | 246 | 246 |
| Air Entrainment (oz) | 17 | 19 | 12 | 11 | 10 | 9 |
| Water reducer (oz) | 23.1 | 20.7 | 18.5 | 24.6 | 21.87 | 19.68 |
| Properties | | | | | | |
| Slump (in.) | 1 | 0.75 | 1 | 2.25 | 2.25 | 2.5 |
| Air Content (%) | 6.5 | 6.4 | 5.5 | 6.2 | 6.4 | 6.5 |
| Unit Weight (pcf) | 139.4 | 140.9 | 137.7 | 137.7 | 139 | 136.8 |
| Conc. Temp. (deg. F) | 71 | 76 | 64 | 69 | 72 | 70 |
| Air Temp. (deg. F) | 63 | 70 | 57 | 60 | 58 | 52 |
| Compr. Strength (psi) | | | | | | |
| 3 days | 1853 | 2023 | 1207 | 1917 | 1983 | 1576 |
| 7 days | 2668 | 2897 | 1958 | 2963 | 2612 | 2235 |
| 14 days | 3180 | 3378 | 2507 | 3642 | 3218 | 2727 |
| 28 days | 4057 | 4225 | 3297 | 4415 | 3803 | 3377 |
| 90 days | 4467 | 5243 | 3737 | 5213 | 4717 | 4382 |
| Flexural Strength (psi) | | | | | | |
| | Required @ 90 days= 750 psi | | | | | |
| 3 days | 380 | 370 | 290 | 360 | 380 | 370 |
| 7 days | 520 | 472 | 370 | 533 | 435 | 398 |
| 14 days | 588 | 568 | 438 | 610 | 517 | 468 |
| 28 days | 667 | 653 | 540 | 650 | 608 | 553 |
| 90 days | 762 | 720 | 602 | 795 | 703 | 627 |

4-4.5 Compliance Checklist.

- The results of the mixture proportioning studies shall be signed and stamped by the registered professional engineer having technical responsibility for the mix design study.
- Provide the maximum nominal coarse aggregate size and the weights and volumes of each ingredient proportioned on a one cubic yard basis. Aggregate quantities shall be based on the mass in a saturated surface dry condition.
- Provide coarse and fine aggregate gradations and plots.
- Provide combined aggregate gradation and coarseness/workability plots.
- Ensure meeting flexural strength, slump, and air content.
- Document required average CQC flexural strength, Ra.
- Recommend proportions/volumes for proposed mixture and each of three trial WCRs.
- Provide individual beam [and cylinder] breaks
- Provide flexural [and compressive]strength summaries and plots.
- Provide correlation ratios for acceptance testing and CQC testing.
- Provide historical record of test results, documenting production standard deviation (if available).

4-5 PLANT PRODUCTION AND CALIBRATION.

4-5.1 Introduction.

After the mix design has been prepared in the laboratory, the next task is to verify that the concrete batch plant can produce the same results. This phase of the work includes an inspection of the batch plant components and a demonstration of plant capability.

4-5.2 Batch Plant Components.

A typical batch plant layout consists of:

- Aggregate stockpiles, bins and conveyors
- Cementitious materials silos
- Water source
- Admixture tanks
- Batching equipment for aggregates, cementitious materials, water, and admixtures.
- Mixer

Industry standards for these components have been established by the Concrete Plant Manufacturers Bureau (CPMB). These standards are available at: <http://www.cpmc.org/>. The specifications require the Contractor to inspect the plant in accordance with the National Ready Mixed Concrete Association (NRMCA) Certification of Ready Mixed Concrete Production Facilities (QC Manual, Section 3), available at: <http://www.nrmca.org/>. The form should be completed by the CQC manager and submitted for approval by the Government. An example of the Check List cover sheet is shown in Figure 4-7.

The footprint of the batch plant layout should provide for:

- Adequate storage of materials for the day's production
- Circulation routes for in-coming material delivery and out-going concrete delivery
- Access from the aggregate stockpiles to the bins
- Clean-out areas for delivery trucks

Site layout factors to consider:

- The site should be graded to promote runoff and minimize ponding during storms
- Provide adequate lighting for night time operations
- Equipment should be supported on engineered foundations, since temporary bracing and blocking may not be adequate to resist the induced loads and vibrations
- Due to the height of the batch plant, on-site batch plants shall be located outside the clear zones to avoid impact to aircraft traffic.
- Coordinate the batch plant location with the base airfield operations manager

4-5.2.1 Aggregates.

- Construct aggregate stockpiles on a paved surface or a minimum of 24-inches of sacrificial material
- Caution the operator delivering aggregates to the bins against digging under the stockpile and intermixing subgrade soil with the aggregate
- Construct aggregate stockpiles in horizontal layers to minimize segregation. Cone-shaped stockpiles are susceptible to segregation (the large aggregate roll to the bottom of the pile)
- No tracked equipment operating on the stockpiles, the tracks can crush the aggregate and change the gradation from that delivered
- Mark stockpiles and bins with the aggregate size or number to facilitate identification
- Maintain adequate distance between stockpiles to prevent cross-contamination
- Provide dividers on bins to prevent cross-contamination during filling

- Verify fine aggregate bin contains an electronic moisture meter probe and the probe is calibrated against an oven-dry moisture sample
- Provide access and templates for sampling aggregates from the belts

Figure 4-7 NRMCA Plant Certification Check List (Cover Sheet)

| | | | | | | | | | | | | | | | | | | | |
|-------------------------------------------------------------------------------------------------------------------------------------------------------------------------------------------------------------------------------------------------------------------------|---------------------------------------------------------------------------------------------------------------------------------------------------------------------------------------------------------------------------------------------------------------------------------------------------------------------------------------------------------------------------------------------------------------------------------------------------------------------------------------------------------------------------------------------------------------------------------------------------------------------------------------------------------------------------------------------------------------------------------------------------------------------------------------------------------------------------------------------------------------------------------------------------------------------------------------------------------------|--------|---|------|---|---|---|----------|--|--|--|--|--|-----------|----|------|---|------|--|
| QC MANUAL SECTION 3 | PLANT CERTIFICATION CHECK LIST | | | | | | | | | | | | | | | | | | |
| <p style="text-align: center;">ENGINEER - PLEASE COMPLETE (P&DT)</p> <p>(Plant Name, Example: "Plant No. 1") _____</p> <p>(Street Address of Plant) _____</p> <p>(City, State and Zip of Plant) _____</p> <p>(Name of Company Operating the Plant) _____</p> | <p style="text-align: center;">FOR NRMCA USE ONLY</p> <p>Reviewed/Checked: _____ Date: _____ Title: _____</p> <p>Plant No. _____</p> <p>Plant Loc. _____</p> <p>Revised/Revised: _____</p> <p>Inspection Date: _____</p> <p>Engineer: _____</p> <p>Comp. Material: _____</p> <table style="width: 100%; border-collapse: collapse;"> <tr> <td style="width: 33%;">Mixing</td> <td style="width: 11%;">M</td> <td style="width: 11%;">S</td> <td style="width: 11%;">C</td> <td style="width: 11%;">P</td> <td style="width: 11%;">S</td> </tr> <tr> <td>Shifting</td> <td></td> <td></td> <td></td> <td></td> <td></td> </tr> <tr> <td>Receiving</td> <td>CM</td> <td>Agg.</td> <td>W</td> <td>Adm.</td> <td></td> </tr> </table> <p>Air Flow: _____ Check/OK/No: _____</p> <p>Dist: _____</p> <p>Wading: YES _____ NO _____</p> <p>Company BUS ID # _____</p> <p>Plant ID # _____ No. Trucks: _____</p> <p>Signature: _____</p> <p>Contact: _____</p> | Mixing | M | S | C | P | S | Shifting | | | | | | Receiving | CM | Agg. | W | Adm. | |
| Mixing | M | S | C | P | S | | | | | | | | | | | | | | |
| Shifting | | | | | | | | | | | | | | | | | | | |
| Receiving | CM | Agg. | W | Adm. | | | | | | | | | | | | | | | |
| Quality Control Manual – Section 3 | | | | | | | | | | | | | | | | | | | |
| <h1 style="margin: 0;">Certification of Ready Mixed Concrete Production Facilities</h1> | | | | | | | | | | | | | | | | | | | |
|  | NINTH REVISION, JANUARY, 2006 National Ready Mixed Concrete Association 300 Spring Street Silver Spring, Maryland 20910 Phone: (301) 587-1400 www.nrmca.org | | | | | | | | | | | | | | | | | | |

4-5.2.2 Cementitious materials:

- Provide separate silos for each type of cementitious material
- Mark silos and supply lines with the type of cementitious material to facilitate identification

4-5.2.3 Water Supply:

- Use water meter to monitor water usage from a base hydrant source

- Provide adequate tank capacity to store water trucked in from other sources
- Provide heating/cooling equipment, as needed to warm or chill the water

4-5.2.4 Admixtures:

- Mark admixture tanks and supply lines with the type of admixture to facilitate identification
- Provide secondary containment around tanks to mitigate spills
- Provide protection (insulation and/or heat tapes) against freezing
- Verify correct admixture and concentration have been provided by the supplier. Many admixtures are provided from the manufacturer in concentrated or powdered form and must be diluted and mixed before use. Concentrated admixtures shall be uniformly diluted, if necessary, to provide sufficient volume per batch to ensure that the batchers will consistently operate within the tolerance listed in paragraph 4-5.2.5
- Dispensing equipment (standpipe or flow meter) should be visible to plant operator

4-5.2.5 Batching Equipment:

- The batching and mixing plant shall be a stationary-type central mix plant.
- The plant shall be designed and operated to produce concrete within the specified tolerances, and shall have a capacity of at least 250 cubic yards per hour.
- All scales and load cells shall be calibrated before use by a certified weighmaster in accordance with National Institute of Standards and Technology (NIST) Handbook 44, Specifications, Tolerances, and Other Technical Requirements for Weighing and Measuring Devices (<http://ts.nist.gov/WeightsAndMeasures/Publications/H44-08.cfm>)
- All water meters and admixture measuring devices shall be calibrated by volumetric measurement.
- All calibrations should cover the full-scale range of the measuring device and include intermittent measurements at 25%, 50%, 75% and 100% of full-scale capacity
- Batching tolerances:
 - Cementitious Materials - ± 1 percent
 - Aggregate - ± 2 percent
 - Water - ± 1 percent
 - Admixtures - ± 3 percent

- For volumetric batching equipment for water and admixtures, the above numeric tolerances shall apply to the required volume of material being batched

4-5.2.6 Mixers.

- Stationary mixers shall be drum or pan mixers.
- Capable of combining the materials into a uniform mixture and discharging this mixture without segregation.
- Do not charge mixers in excess of the capacity recommended by the manufacturer.
- Operate at the drum or mixing blade speed designated by the manufacturer.
- Provide with an acceptable device to lock the discharge mechanism until the required mixing time has elapsed
- Maintain in satisfactory operating condition, and keep the mixer drums free of hardened concrete. Replace mixer blades or paddles when worn down more than 10 percent of their depth as compared with the manufacturer's dimension for new blades or paddles.

4-5.3 Uniformity Test.

After the batch plant has been inspected and approved, the uniformity test is performed. The uniformity test is used to verify the Contractor's proposed batch weights, charging sequence, and mixing time can produce the required fresh and hardened concrete properties. The method is based on sampling and testing three locations in each of three separate batches.

The default mixing time is specified as:

“...the mixing time for each batch after all solid materials are in the mixer, provided that all of the mixing water is introduced before one-fourth of the mixing time has elapsed, shall be 1 minute for mixers having a capacity of 1 cubic yard. For mixers of greater capacity, this minimum time shall be increased 20 seconds for each additional 1.33 cubic yard or fraction thereof.”

For a typical 9 cubic yard batch, the default mixing time is 180 seconds, which most batch plant operators would consider as a major impact on production. The uniformity test is used to validate that a shorter mixing time is satisfactory. The minimum mixing time for full batch production shall be 75 seconds to insure adequate distribution of air content throughout the batch.

The uniformity test is conducted in accordance with CRD-C 55 (available at: <http://www.wes.army.mil/SL/MTC/handbook/handbook.htm>). All

testing for each batch must be completed in 45 minutes. Three separate batches are required.

Preliminary factors to consider:

- Verify adequate quantity of materials is available, the batch plant is inspected and calibrated, and the approved mix design has been loaded into the batch plant computer system.
- Select a smooth, preferably paved, area close to the batch plant and on-site laboratory to perform the sampling and testing.
- Have an adequate number of ACI-certified technicians available. Six tests must be performed on each of three separate samples from three separate batches, so a single technician dedicated to each test method is recommended. Assign an additional technician the job of recording all the results.
- Establish separate testing locations so the technicians can operate without getting in each other's way. A typical layout and staffing is shown on Figure 4-8.

Figure 4-8 Typical Layout of Uniformity Testing Stations



A step-by-step procedure for a single batch is outlined below.

- Have the Contractor identify the proposed batch size and mixing time
- Batch and mix the first batch, discharge into transport vehicle and move to sampling area. Do not use a front-end loader to transport concrete.

- Discharge the batch in a long pile. Do not dump in a single pile. See Figure 4-9.

Figure 4-9 Spreading a Batch for Sampling



- Sample concrete in accordance with ASTM C 172. Obtain individual samples from the first, second and third portions of the batch, see Figure 4-10. Do not mix samples from the individual thirds.

Figure 4-10 Sampling Locations Within A Batch

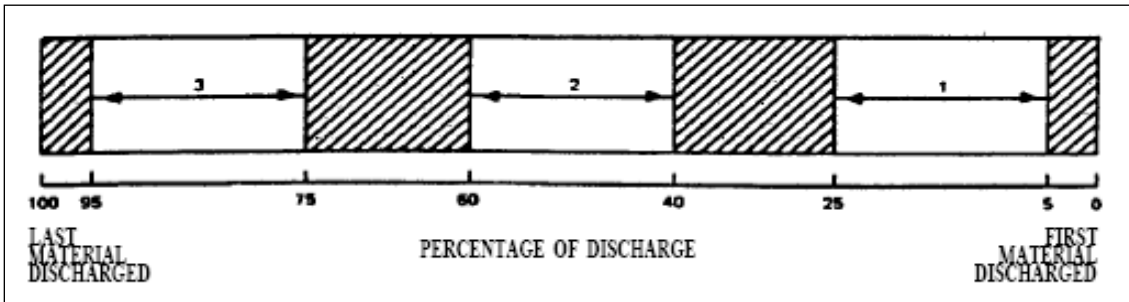

- Conduct testing on each of the third-point samples:

- Unit weight of air-free mortar (pounds per cubic foot)
- Air content (percent)
- Slump (inches)
- Coarse aggregate (percent)
- Compressive strength at 7 days (psi)
- Water content (percent).
- Record the individual values for each test and determine the range for each test (highest value minus lowest value), see Figure 4-11.

Figure 4-11 Uniformity Test Results For A Single Batch

| Corps of Engineers U.S. Army | | Concrete Uniformity Batch Report | | | | |
|--------------------------------------------------------|----------------|-------------------------------------|---------------|-------------|------------------|-------|
| Project: Reservoir | | Date: 23 May | | | | |
| Name, Mfg. of Mixer: Kochring-Johnson | | | | | | |
| Type, Cap. of Mixer: Tilt Model 168-S. 6.2 cu yd | | Slump, in.: 2-1/4* | | | | |
| Mixing time: 3 min. | | Batch size: 6.0 cu yd | | | | |
| Mix: Exterior | Batch: #1 | Max. size aggregate: 3 in. | | | | |
| Test Results | | | | | | |
| | | Front Sample | Middle Sample | Rear Sample | Ave. (3 Samples) | Range |
| Total Mass, lb | | 301.5 | 245.0 | 266.0 | | |
| Water, % | 1st Specimen | 10.9 | 10.0 | 10.5 | | |
| | 2nd Specimen | 10.7 | 10.4 | 10.7 | | |
| | Ave. (2 Spec.) | 10.8 | 10.2 | 10.6 | | 0.6 |
| Unit Weight of Mortar, lb/ft ³ | | 139.5 | 140.0 | 141.2 | | 1.7 |
| Coarse Aggregate, % | | 54.7 | 52.0 | 53.0 | | 2.7 |
| Air Content, %* | | 5.6 | 4.8 | 4.3 | | 1.3 |
| Slump, in. | | 3.0 | 2-1/2 | 3-1/4 | | 3/4 |
| 7-Day Comp. Strength, psi | 1st Specimen | 3100 | 3350 | 3200 | | |
| | 2nd Specimen | 3070 | 3150 | 3150 | | |
| | 3rd Specimen | 3070 | 3370 | 3220 | | |
| | Ave. (3 Spec.) | 3080 | 3290 | 3190 | 3187 | 210 |
| *On the portion passing the 37.5-mm (1-1/2-in.) sieve. | | | | | | |
| Remarks: | | | | | | |

- If any one test range is outside of the specification limit, do not waste time by running the other batches. Adjust the batch size, charging sequence, and/or mixing time and repeat the three-batch sequence from the beginning.
- Repeat the process for the additional batches. Record the data on the individual batch report sheets.

- Summarize the three batches on the summary report sheet (Figure 4-12) and average the three ranges for each test. Compare the average range with the specification limits for each test

Figure 4-12 Uniformity Test Summary

| Corps of Engineers U.S. Army | | | Concrete Uniformity Summary Report | | | | | | |
|--------------------------------------------------|----------------|--------------|------------------------------------------|---------------------------------|----------------------------|----------------|------------------------------|----------------|--|
| Project: Reservoir | | | | Date: 24 May | | | | | |
| Name, Mfg. of Mixer: Koehring-Johnson | | | | | | | | | |
| Type, Cap. of Mixer: Tilt Model 168-S, 6.2 cu yd | | | | | | | | | |
| Mixing time: 3 min. | | | | Batch size: 6.0 cu yd | | | | | |
| Mix: Exterior | | | | Nom. Max. size aggregate: 3 in. | | | | | |
| Portion | Cement | Water | Admixture | Fine Aggregate | Coarse Aggregate | Total | | | |
| Mass, lb | 1,692 | 1,098 | 450 | 6,600 | 14,280 | 24,120 | | | |
| Volume, cu ft | 8.6 | 17.6 | 2.9 | 40.4 | 85.8 | 155.4 | | | |
| Type | II | -- | Fly Ash | Natural Sand | Crushed Limestone | -- | | | |
| Results, Range | | | | | | | | | |
| Batch No. | Slump, in. (a) | Water, % (b) | Unit Wt of Mortar lb/ft ³ (c) | Coarse Aggregate, % (d) | 7d Comp. Strength | | | Air Content, % | |
| | | | | | Ave. of 3 Samples, psi (e) | Range, psi (f) | % Range (g) = (f)/(e) × 100% | | |
| 1 | 3/4 | 0.6 | 1.7 | 2.7 | 3187 | 210 | 6.6 | 1.3 | |
| 2 | | | | | | | | | |
| 3 | | | | | | | | | |
| Ave. (3 Batches) | | | | | | | | | |
| Remarks: | | | | | | | | | |

4-5.4 Compliance Checklist.

- Mix design submitted and approved
- Batch plant inspected and calibrated
- NRMCA Plant Certification Check List submitted and approved
- Contractor's proposed batch quantity, charging sequence and mixing time submitted
- Personnel and equipment for uniformity testing available
- Each separate batch of uniformity tests completed within 45 minutes
- Uniformity tests completed and submitted

4-6 TRUCK MIXERS.

4-6.1 Introduction.

Truck mixers are available in two styles: 1) transit mix trucks with a rotating drum to mix and agitate the concrete and 2) volumetric mix trucks with a conveyor belt and auger system to proportion and mix the concrete. This chapter will discuss both styles of mixers and their appropriate use.

4-6.2 Transit Truck Mixers.

Truck mixers shall not be used for mixing or transporting slipformed paving concrete. The low slump required for successful slipform placement makes discharge difficult from a transit mixer.

Transit mix trucks are suitable only for mixing and transporting concrete to be placed by hand or in fixed-forms.

A cross-section of a transit mixer drum is shown on Figure 4-13. The drum revolves in one direction while mixing or agitating the load. When discharging the load, the drum rotation is reversed and the concrete is elevated up the spiral blades to the discharge chute.

Figure 4-13 Cut-Away View of Transit Mix Drum



4-6.3 Transit Mixer Modes.

Transit mix drums can operate at mixing or agitating speed, depending on how the concrete is batched into the drum. ASTM C 94 describes three modes as discussed below.

4-6.3.1 Central Plant Mix. Concrete that is completely mixed in a stationary (central-plant) mixer shall be transported in a truck mixer operating at the speed designated by the manufacturer of the equipment as agitating speed.

4-6.3.2 Shrink-Mixed Concrete. Concrete that is first partially mixed in a stationary (central plant) mixer, and then mixed completely in a truck mixer, shall conform to the following: The time of partial mixing in the stationary mixer shall be minimum required to intermingle the ingredients. After transfer to a truck mixer, the amount of mixing at the designated mixing speed will be that necessary to meet the requirements for uniformity of concrete as indicated in ASTM C 94, Annex A1. Additional turning of the mixer, if any, shall be at a designated agitating speed. The total number of revolutions before discharge shall not exceed 300.

4-6.3.3 Truck-Mixed Concrete. Concrete that is completely mixed in a truck mixer shall be mixed at 70 to 100 revolutions at the mixing speed designated by the manufacturer to produce the uniformity of concrete indicated in ASTM C 94, Annex A1. Additional revolutions of the mixer beyond the number found to produce the required uniformity of concrete shall be at the designated agitating speed. The total number of revolutions before discharge shall not exceed 300. When satisfactory performance is found in one truck mixer, the performance of mixers of substantially the same design and condition of blades are permitted to be regarded as satisfactory.

4-6.4 Truck Mixer Components.

A transit truck mixer consists of:

- Registration plates,
- Mixing drum and mixer blades,
- Water tank and measuring devices,
- Admixture tanks,
- Revolution counter.

Industry standards for these components have been established by the Truck Mixers Manufacturers Bureau (TMMB). These standards are available at: <http://www.tmmb.org/>. The specifications require the Contractor to inspect each transit truck in accordance with the National Ready Mixed Concrete Association (NRMCA) Inspection & Certification of Delivery Vehicles (QC Manual 3, Section

5), available at: <http://www.nrmca.org/>. The form should be completed by the CQC manager and submitted for approval by the Government.

4-6.4.1 Registration Plates:

- TMMB discharge rating plate, see Figure 4-14.
- Manufacturer's plate listing recommended operating speed for mixing, which must be in the range of not less than four or more than 22 rpm.
- Manufacturer's plate listing recommended maximum agitating speed which must not exceed six rpm.

Figure 4-14 TMMB Discharge Rating Plate 1



NOTE: Mixing capacity is less than agitating capacity of the drum. The maximum mixer capacity (C, in cubic yards) can be computed from the minimum gross rated capacity (V, in cubic feet) of the drum from:

- For V less than 7.65 cubic yards (206 cubic feet)
 $V = 45C - 8.55$
- For V of 7.65 cubic yards (206 cubic feet) or greater
 $V = 46.96C - 23.48$

4-6.4.2 Mixing Drum and Blades:

- Interior condition should be satisfactory: no appreciable accumulation of hardened concrete; blades free of excessive wear. Blade wear shall be checked at the point of maximum drum diameter nearest to the drum head. When the height of the blade at this point, measured from the drum shell, is less than 90 percent of the original radial height (dimension "X" in Figure 4-15 for the applicable blade type), the blade

is considered excessively worn. The manufacturer of the mixer will furnish original blade dimensions on request.

Figure 4-15 Mixer Blade Types 1

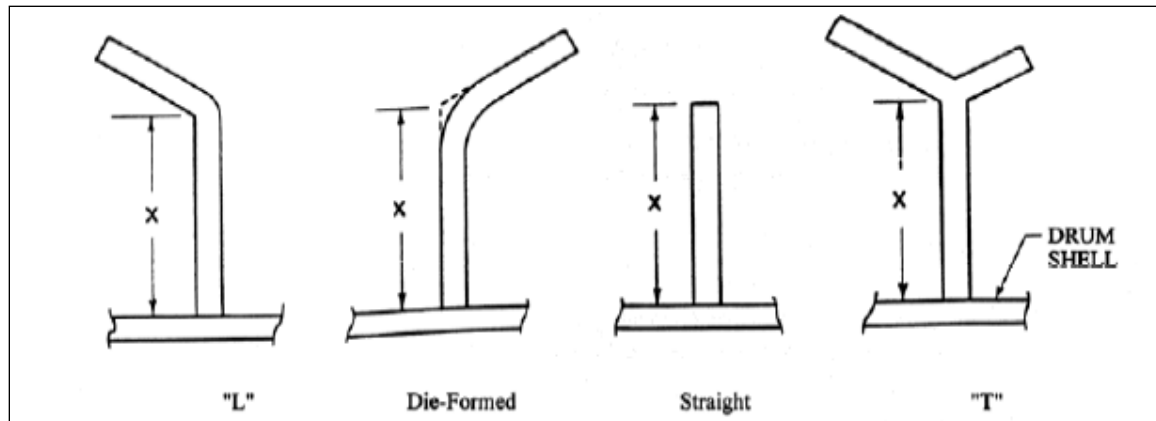

- Charging and discharge openings and chute must be in good condition: free from appreciable accumulations of cement or concrete; hopper and chute surfaces clean and smooth.
- Drum or container must be of such size that the rating as a mixer (in volume of mixed concrete) does not exceed 63 percent of the gross volume of the mixer and the rating as an agitator does not exceed 80 percent of the gross volume, disregarding blades. (This requirement is met by all mixers carrying a rating plate of the Truck Mixer Manufacturer Bureau.)
- Truck mixers, agitators, and front discharge concrete carriers must be equipped with a hatch in the periphery of the drum shell of such design to permit access to the inside of the drum for inspection, cleaning and repair of the drum and blades. The typical location of the inspection port on an inclined-axis revolving drum is shown on Figure 4-16.
- Do not inspect the drum by looking into the drum interior from the top of the discharge chute. One cannot observe the bottom of the blade flight.

Figure 4-16 Inspection Port on Inclined-Axis Revolving Drum



4-6.4.3 Water Tank and Measuring Devices:

- Truck mixers, agitators and front discharge concrete carriers shall be furnished with one of the following options:
 - No water tank or system.
 - Flush water tank only and water system. The total capacity of the tank(s) shall be not more than 50 gallons per cubic yard of maximum mixer capacity. The tank(s) may be equipped with an automatic measuring device. The tank(s) shall also be equipped with sight gauges on all compartments, on which the gauge markings shall be visible through the entire range. Measuring tank(s) shall be equipped with necessary plumbing to provide for checking their calibration.
 - Mix and flush water tank(s) and water system. If a flush water tank(s) is furnished, the total capacity of the tank(s) shall not exceed 25 gallons per cubic yard of maximum mixer capacity. The tank(s) shall be equipped with a gauge glass on which the markings shall be visible for the entire range.
- Water measuring devices shall be required whenever a water tank(s) is furnished. The water measuring device shall be one of the following types:
 - Automatic cut-off siphon type,
 - Water meter of the automatic shut-off type,
 - Sight gauge(s).

Whenever a mix and flush water tank(s) is furnished, an automatic water measuring device may be required. It shall be one of the two automatic devices described.

On new equipment, automatic water measuring devices shall be accurate to 1 percent of the total capacity of the tank(s) when the truck mixer or front discharge concrete carrier is stationary and essentially level.

- Water pump. A water pump or other method for delivering water shall be furnished with the water system. The water system shall be capable of delivering not less than 45 gallons of water per minute into the batch, providing, in the case of air pressure systems, that the air delivery from the truck or concrete carrier is sufficient.
- Water Injection. Water for the entire batch, when taken only from the truck mixer or front discharge concrete carrier water system, shall be introduced into the batch at the head section of the drum or by dual injection into the head and discharge section of the drum.

4-6.4.4 Admixture Tanks and Measuring Devices:

- Separate tanks shall be provided for each admixture.
- Admixtures shall be injected into the drum through the water injection system.

4-6.4.5 Revolution Counters:

- Digital or mechanical revolution counters are required.
- Mechanical counters are triggered by contact between the revolving drum and the arm of the counter. Verify the arm is functioning, see Figure 4-17.

Figure 4-17 Mechanical-Arm Revolution Counter



4-6.5 Uniformity Test.

The uniformity test for truck mixers is similar to the batch plant mixer uniformity test described in Section 4-5.3. The methodology is specified in ASTM C 94. Only a single batch is required.

A step-by step procedure for a single truck uniformity test is outlined below:

- The truck to be tested for mixer uniformity should be selected from the available fleet or those dedicated to the project.
- Verify trucks have been inspected and certified in accordance with NRMCA QA Manual, Section 5.
- Group the trucks by blade design (Figure 4-15) and select one truck from each group. Perform uniformity tests on each selected truck.
- Batch and mix the Contractor's proposed quantity of concrete.
- Sample concrete in accordance with ASTM C 172. Obtain individual samples after discharge of approximately 15 percent and 85 percent of the load.
- Conduct testing on each of the two samples:
 - Unit weight of air-free mortar (pounds per cubic foot),
 - Air content (percent),
 - Slump (inches),
 - Coarse aggregate (percent),
 - Compressive strength at 7 days (psi),
 - Unit weight, air-free basis (pounds per cubic foot).
- Compare the differences of each sample from each location against the permissible limits tabulated in ASTM C 94, Annex A1.

4-6.6 Volumetric Mixers.

Volumetric mixers use a combination of: 1) volumetric measurement of cementitious materials, aggregates, water and admixtures and 2) continuous mixing to produce concrete.

These mixers are best suited to producing quantities for small volume placements, such as patch and repair projects. They are not suited for high production placement, since they must frequently recharge the aggregate bins and cement silo. A typical mobile volumetric mixer is shown on Figure 4-18.

Figure 4-18 Typical Mobile Volumetric Mixer

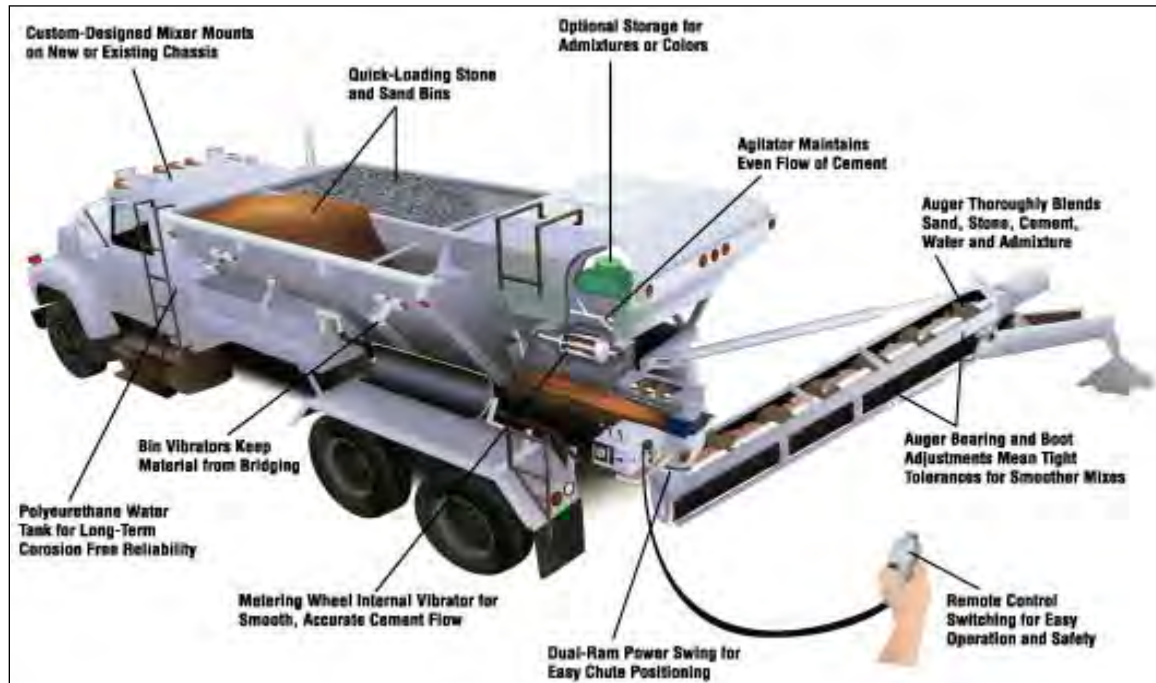

Standards for volumetric mixers have been established by the Volumetric Mixer Manufacturers Bureau (VMMB), <http://www.vmmb.org>. A standard for conducting mixer uniformity tests is available from ASTM as C 685. Further guidance on volumetric measuring and continuously-mixed concrete is available from ACI as committee report 304.6R.

The previous recommendations for inspection and calibration of central-mix and transit mix equipment are also applicable to the mobile volumetric mixers. All volumetric mixers proposed by the Contractor must be inspected and have a uniformity test conducted, using the proposed materials and mix proportions.

4-6.7 Compliance Checklist.

- Transit Mix Trucks:
 - Review truck inspection submittal
 - Select a random truck:
 - Pull the inspection hatch, confirm blade condition, and function of water discharge nozzle.
 - Verify revolution counter works,
 - Check legibility of water tank standpipe.
 - Verify Contractor's proposed mixer capacity in accordance with TMMB plate and manufacturer's certification.
 - Observe uniformity test on trucks and check submittal results.
 - Check truck IDs on the job against inspection record to verify no un-inspected trucks used.
- Volumetric-Mixer Trucks:
 - Review truck inspection submittal
 - Observe uniformity test on trucks and check submittal results.
 - Check truck IDs on the job against inspection record to verify no un-inspected trucks used.

4-7 SURFACE PREPARATION AND DEMOLITION.

4-7.1 Surface Preparation.

The underlying material for the concrete has to be clean, damp (Figure 4-19), and free from debris, waste, frost, ice, and water. It has to be adequately compacted and to correct thickness, grade and smoothness. Care shall be taken to insure the correct subgrade and base courses are adjusted for thickened edged pavement joints. Each layer has to be transitioned down full thickness and not scalped off. Variations in grade and smoothness will result in the pavement thickness variations and quantities. In many cases different subcontractors are used to construct the base courses and others construct the concrete pavement. Disputes can arise when these contract tolerances are not met and even though it is a dispute between the contractors, it becomes a problem for everyone including the schedule. Insuring that the contract requirements are met, will avoid these types of problems.

Figure 4-19 Dampening the Base Course



Low areas of the base have to be filled and compacted to a condition similar to that of surrounding grade, or filled with concrete monolithically with the pavement. These areas filled with concrete cannot be cored for thickness to avoid biasing the average thickness used for evaluation and payment adjustment. Any underlying material disturbed by construction operations (Figure 4-20) has to be reworked and re-compacted. For slipform paving the same underlying material under the paving lane has to be continued beyond the edge of the pilot for the paver track support.

Figure 4-20 Disturbed Base Course from Equipment



Transporting equipment should not be allowed to operate on the prepared underlying material. Operating hauling equipment in the paving lane will cause the paver to stop frequently, producing a discontinuity in the pavement surface. Also it can disturb the compacted base course.

4-7.2 Checklist for Surface Preparation.

- Base clean & free of debris.
- Tested for density.
- Test for in-place gradation for free draining bases.
- Surveyed for grade & crown.
- Checked for smoothness.
- Correct areas by trimming or addition of material and recompact.
- Thickened edge joint locations graded with required base thickness.
- Base extended beyond paving lane for paver support.
- Moisten prior to paving.
- No trafficking of trucks or equipment prior to and during paving.
- Compact any disturbed area.

4-7.3 Demolition.

Hardened concrete pavement may have to be removed to construct new pavement or because the new pavement is defective per the contract. In both cases, care is required to maintain adjacent pavement. The contract outlines the methods that are to be strictly followed.

To avoid disputes on contractor damage, an inventory of the pavement distresses (cracks, spalls, and corner breaks), should be performed along the existing pavement edge. After pavement removal, the remaining edge shall again be surveyed after removal to quantify any damage caused by Contractor's operations. Repair methods will be outlined in the contract and some pavement may be required to be removed and replaced.

When existing concrete pavement is to be removed and adjacent concrete is to be left in place, the joint between the removal area and adjoining pavement to stay in place has to be first cut full depth (Figure 4-21) with a standard diamond-type concrete saw. By not cutting directly on the joint line and moving back at least one inch, some existing spalling can be removed. This is also important in removing the irregular crack surface at contraction joints.

Figure 4-21 Full Depth Sawcut



Next, a full depth saw cut is made parallel to the joint at least **24 inches** from the joint and at least **6 inches** from the end of any dowels. This will avoid potential damage as shown in Figure 4-22. This saw cut is be made with a wheel saw (Figures 4-23 and 4-24).

Figure 4-22 Damage from Partial Depth Sawcut



Figure 4-23 Wheel Saw



Figure 4-24 Second Cut with Wheel Saw, minimum 24-inches from Initial Saw Cut



Care has to be taken to remove the concrete between this last saw cut and the joint line. Figures 4-25 and 4-26 show inadequate care to protect pavements that are to remain in place. The double cutting will insure that the removal operations do not cause the remaining adjacent panel to spall or under-break as shown in Figure 4-27.

Figure 4-25 Improper removal Techniques - No Double Saw Cut



Figure 4-26 Improper Removal Technique, no Double Saw Cut



Figure 4-27 Under-breaking from Incorrect Removal Techniques

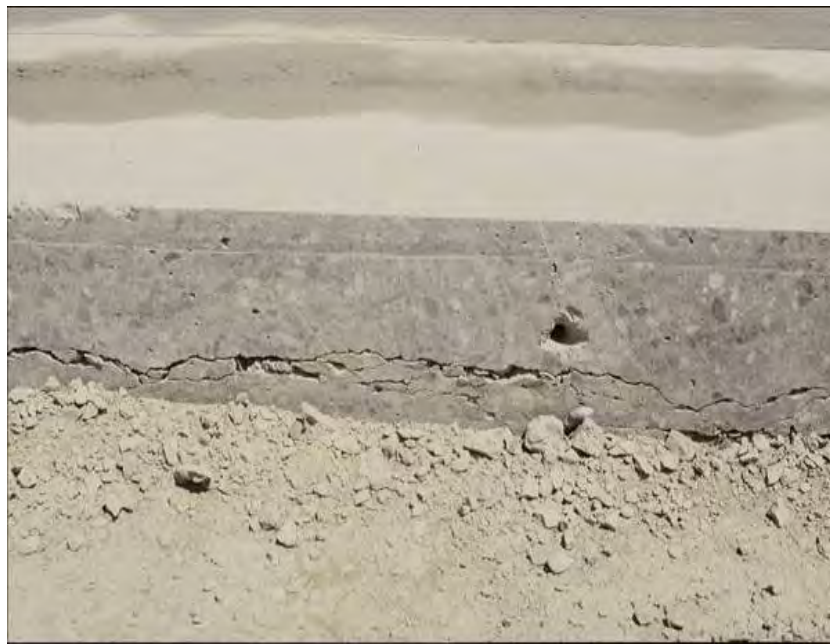

Figure 4-28 shows demolition using a drop hammer. The edges that are damaged (Figure 4-29) may be cause for additional removal. After demolition, the adjacent pieces should be removed by pulling pieces and blocks away from the joint face before removal. In lieu of this method, this strip of concrete may be carefully broken up and removed using hand-held jack-hammers or other approved light-duty equipment which will not cause stress to propagate across

the joint saw cut. Another option is to sawcut the slab full depth to divide it into several pieces and each piece lifted out and removed as shown in Figure 4-30. It is important that a truly vertical lift is made so adjacent concrete is not spalled or damaged. The edge of existing concrete pavement against which new pavement abuts has to be protected from damage at all times. Slabs which are damaged during construction are to be removed and replaced unless repair is permitted per contract.

Figure 4-28 Demolition with Drop-Hammer



Figure 4-29 Demolition With No Protection of Adjacent Concrete



Figure 4-30 Removal of Saw-Cut Pavement Pieces



Resonant pavement breakers have been used successfully to demolish or rubblize thick airfield concrete pavements. The concrete can be removed easily or used as a base. This method will rubblize the existing concrete using a high frequency/low amplitude vibration (Figures 4-31, 4-32, 4-33 & 4-34). They have proven to be effective, efficient and have not damaged the base courses. They must have a solid and well drained base to work effectively.

Figure 4-31 Diagram of Resonant Rubblizing

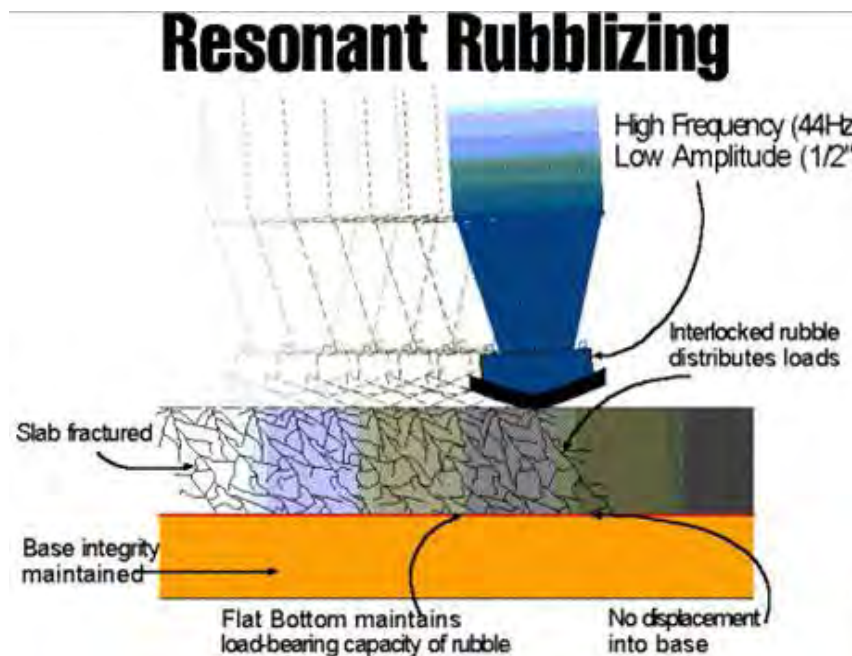

Figure 4-32 Resonant Pavement Demolition



Figure 4-33 Rubblized Surface With The Resonant Rubblizing Technique



Figure 4-34 Resonant Rubblized Section



4-7.4 Checklist for Demolition.

- Perform an inventory of existing pavement conditions including spalls and other distresses.
- Double saw cut Pavement to be removed.
- Initial Saw cut – full depth,
- Second cut 24-inches from joint (minimum 6-inches for dowel), full depth with wheel saw.
- Pull adjacent section away from joint carefully.
- Protect joints and concrete to remain in place.
- Optional method to cut into pieces and lift out.
- Demolition procedures in test section.
- Replace any damaged pavement.

4-8 PLACEMENT OF REINFORCEMENT/ LOAD-TRANSFER:

4-8.1 Introduction.

When reinforced concrete is used, the steel should be placed in the concrete at the specified location by using chairs, Dobie blocks, or by placing the concrete in two layers. Normally designs call for reinforcement steel to be used in odd or

irregular)-shaped panels, where the length to width ratio of the panel exceeds 1.25:1. For the panels and sections 12-inches thick and less, the steel has to be placed on chairs adequately to support the weight of the concrete being placed and consolidated. (Figures 4-35 and 4-36) The steel should not be continued through the contraction joints. The steel should never be placed on the ground and pulled into place after concrete is placed. Also workers should never stand on it during concrete placement or consolidation of the concrete.(Figure 4-37) When steel is not correctly placed, cracks or other damage may occur to the PCC prior to being subjected to traffic.

Figure 4-35 Steel Adequately Supported For Odd-Shaped Panels



Figure 4-36 Reinforcement Steel for Odd (or Irregular)-Shaped Panels



Figure 4-37 Workers Standing on Reinforcement Steel during Concrete Placement



4-8.2 Slipform Construction.

For reinforced slipform paving, one layer of concrete can be placed and consolidated followed by the reinforcing steel placement (Figure 4-38), and then the top layer of concrete placed and consolidated. The time limit will be less in hot weather. This is the strike-off method and should be done when the pavement is over 12-inches thick in order for the concrete to be consolidated full depth. The thickness of the first lift should be increased to allow for the steel to be pushed down into the surface of the first lift to the correct elevation prior to the second lift. Steel mats should be delivered flat to avoid bends and insure correct positioning.

This technique has to be done within 30 minutes of placement of the top lift. The method has to insure that the steel does not move and provide clearance. In order to avoid random cracking, the steel has to be positioned to avoid the contraction joint and remain 3- inches from the joint faces (Figures 4-39 and 4-40).

Figure 4-38 Strike-off Method for Placement of Reinforcing Steel



Figure 4-39 Gap in Reinforcing steel at Contraction Joint



Figure 4-40 Cracked Panels from Misplaced Reinforcement Steel



4-8.3 Reinforcement Checklist.

- Steel held securely to withstand weight of concrete placement and consolidation.
- Steel supported by corrosion free chairs or Dobie blocks.
- Work bridges available to prevent workers from standing on reinforcing steel.
- Adequate clearance from bottom, side and surface to avoid future corrosion.
- Steel not excessively (flakey) corroded or contaminated to affect bond.
- Steel is correct size and spacing.
- Steel is placed at the correct depth (usually $T/4 + 1$ - inch from the top).

4-8.4 Placement of Dowels.

The placement of dowels is critical to provide a joint that can open and close and transfer load to the adjacent slab. Dowels have to be smooth with no burrs from manufacturing and painted to minimize corrosion potential. Epoxy paint coating is required. The coating has to uniformly cover the bar (Figure 4-41). It cannot be dipped while in the bundle. Typically one end of the dowel will be fixed in the

concrete and one end will be lubricated (Figure 4-42). Figure 4-43 shows ends of dowels that have not been painted with the epoxy coating. The lubrication should be an oil or a light (not globs) coating of grease. Glob of grease would create voids and reduce the effectiveness of the load carrying capability. Dowels will be typically used in construction joints, but are also used in contraction joints (Figure 4-44). (Construction joint is the joint where the pavement ends along the side or end. Contraction joints are typically sawcut into the pavement to control the location of the cracks.) The methods for installation are different for both, but in all cases have to provide horizontal and vertical alignment within 1/8-inch per foot.

Figure 4-41 Non-uniform Coating of Paint (Note: Not Epoxy Coating)

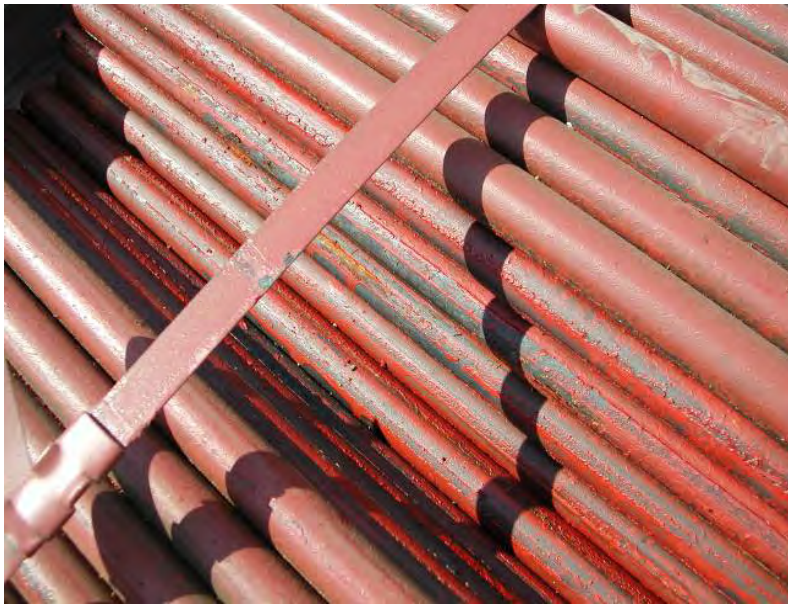

Figure 4-42 Dowels Installed on Construction Joint (Note: Not Epoxy Coating)



Figure 4-43 Dowel Ends not Epoxy Coated



Figure 4-44 Dowels at Contraction Joints



4-8.5 Dowel Checklist

- Dowels smooth with no burrs.
- Dowel bar correct diameter, length and grade steel.
- Corrosion protection uniformly over at least half of the length (slip end).
- Lubrication applied uniformly on the slippage end without heavy deposits of grease.
- Dowels are epoxy coated and nicks are touched up.
- Check that installation (X, Y, Z) conform to details and grout disks are installed properly.

4-8.6 Dowel Spacing.

Dowel spacing has to be planned prior to construction in order to avoid transverse joints and to avoid interference with dowels placed in contraction joints by at least 6 inches. It is helpful if the designer provides a plan showing the detail of the bar spacing, and if not then one should be developed by the contractor.

The plan should show how the dowel locations relate to joint locations. The plan should provide for a consistent joint space to avoid conflict with the transverse joints (see Figure 4-45). It should also show the transverse contraction joint

dowels and the appropriate setback to avoid the construction joint as shown in Figure 4-46. The dowels in the construction joints should always take precedence over the contraction joint dowels. Load transfer depends totally on dowels in the construction joints but the contraction joints have the additional benefit of the aggregate interlock.

Figure 4-45 Dowel Bar Spacing Detail

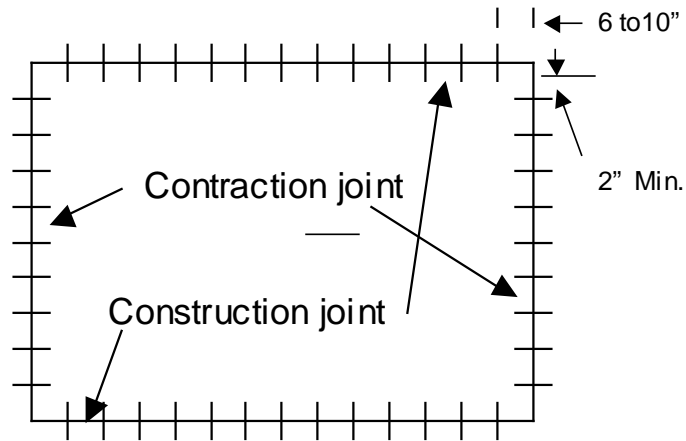

Figure 4-46 Dowel Located on a Contraction Joint.



EXAMPLE: A proposal to pave a lane 20 feet wide and contraction joints are to be installed every 20 feet. The dowel length is 20 inches and the maximum spacing is 18 inches. In order to set the drill up to drill multiple holes and avoid contraction joints, a consistent hole pattern is required. For the 20 feet or 240 inches at a 18 inch maximum spacing, 13.33 spaces is calculated. Since there will be a half space adjacent to each contraction joint, the number of dowels would be equivalent to the calculated number of spaces. In order to meet the maximum spacing of 18 inches, this would require 14 dowels between each joint. This provides for a 17.14 inch spacing between dowels and 8.57 inch end spacing at the joints.

The dowels in the contraction joint will have to be installed in baskets and the end dowels have to provide clearance to the construction joint dowel end by 2 inches. The nearest dowel could be set at 12 inches from each construction joint. The remaining available distance is 216 inches between the last contraction joint dowels at each end. This would calculate to 12 even spaces or 13 dowels at 18 inch even spacing.

4-8.7 Dowel Placement Checklist.

- Dowel spacing plan developed and available to install dowels at a uniform spacing.
- Contraction joint dowels have adequate clearance to construction joint dowels.
- Construction joint dowel locations are planned to be evenly spaced and to avoid contraction joints.
- Dowels placed at midpoint of slab within the required tolerances.

4-8.8 Dowelled Contraction Joints.

Dowels on contraction joints can be installed either by placing securely in baskets prior to paving (Figure 4-47) or by inserting from the surface behind the paver screed. The use of wire baskets is the most common approach but there are several items to watch for in order to make sure that it is done correctly. When baskets are used, alternating dowel ends are welded to the basket. For this method to insure slippage, the entire dowel should be painted and lubricated.

The elevation of the dowels has to be within the tolerances and the paver vibrators have to clear the dowel and the basket. The end dowels have to be far enough from the longitudinal construction joint so they do not interfere with the construction joint dowel. Place concrete on the basket in a manner that it does not collapse or move the dowel alignments.

Figure 4-47 Securing Dowel Baskets



4-8.8.1 Dowel Inserters in Contraction Joints. Inserters (Figure 4-48) used to place dowel bars in contraction joints vary in performance. The inserter has to place the dowel bar accurately while consolidating the concrete around the dowel. The concrete has to be stiff enough to support the weight of the dowel so it does not settle out of tolerance (Figures 4-49 and 4-50). If inserters are proposed, check dowel vertical and horizontal alignment in the test section and occasionally during production. Successful insertion of the contraction joint dowels occurs when adequate checks are made. Coring to check alignment or possible voids should be done if there are any suspected problems.

Figure 4-48 Inserting Contraction Joint Dowels – Slipform Construction



Figure 4-49 Misaligned Contract Joint Dowels



Figure 4-50 Misaligned Contract Joint Dowels



4-8.9 Contraction Joint Dowel Checklist.

- Dowels in basket with every other end welded.
- Non- welded end painted with epoxy coating and lubricated.
- Baskets secure to base including the end of the baskets to minimize chance of movement or deformation.
- Baskets and dowels set to correct alignment for contraction joints and avoid conflict with construction joint dowels.
- Paver vibrators set to clear the dowels in baskets.
- Baskets strong enough to stay aligned during placement and consolidation.
- When inserters are used for contraction joint dowels, the method and operation has to be demonstrated in the test section.
- Any suspected misalignments or voids should be checked for by coring.

4-8.10 Doweled Construction Joints.

The method used in installing and holding dowels in position shall ensure alignment within tolerances and provide load transfer to the adjacent slabs with no voids. Dowels placed in drilled holes and not grouted are not acceptable. Dowels cannot be contaminated with excessive lubrication, epoxy waste or dry mortar since it will affect the load carrying capability or movement within the concrete.

4-8.10.1 Fixed Form Paving - Dowel Installation. Dowel installation in fixed form construction (Figure 4-51) should be at the correct location in the center of the slab. Contractors sometimes try to reuse forms with predrilled holes that are adjusted on the top or bottom. This practice may not provide the correct spacing and is not acceptable. The forms should have a device that will hold the bar securely in the proper position. The bar has to be maintained securely from movement during placement, consolidation, and finishing the concrete. The holes should also be oversized with grommets that prevent leakage of mortar and permit form removal without damage to the concrete.

Wood forms should not be used. Plastic sleeves for providing void or inserted space for inserted dowels are not permitted (Figure 4-52).

The majority of the dowel loading is carried in the first few inches from the face of the concrete joint. It is extremely important that the concrete be fully consolidated around the bar up to the face of the joint.

Figure 4-51 Dowels in Steel Forms



Figure 4-52 Plastic Sleeves on Wood Forms



4-8.10.2 Dowels in Slipform Construction Joints. Dowel inserters for construction joints are never to be used or even tested for pavements. Numerous attempts have been made over the years and have never been completely successful or consistent. Figures 4-53, 4-54, and 4-55 show the poor quality from using dowel inserters in construction joints.

Figure 4-53 Voids around an Inserted Dowel



Figure 4-54 Voids around an Inserted Dowel



Figure 4-55 Alignments of Inserted Dowels



In order for a dowel to be inserted, the concrete has to be consolidated sufficiently to expel any air voids to the surface and maintain the edge and alignment. This has never been successfully demonstrated and not likely with slipform pavers with trailing forms and considering the cantilever weight of the steel dowel in fresh concrete. The edge will be irregular and excessive air will be entrapped in the concrete. It is impossible to maintain a dowel cantilevered in the side of a slipformed pavement section without settlement of the dowel. When this occurs, load transfer will only be in one direction. Pullout testing alone is not an indication of the dowel's effectiveness for load transfer.

Test sections and production pavement should never be used to demonstrate any dowel inserter proposed for construction joints. Plastic sleeve inserters have also been attempted and have not provided consistent alignment. The same problem with voids in the concrete exists and this procedure should not be attempted on projects. Contract conformance should be maintained for drilling and grouting of the dowels.

Dowels are to be installed in slipform construction joints by drilling (Figure 4-56) and grouting in the hardened concrete. The concrete has to be cured for 7 days or have a minimum compressive strength of 2500 psi or flexural strength of 450 psi prior to drilling. Figure 4-57 shows a joint with drilled holes for the dowels. The holes should be 1/8 inch greater than the dowel diameter in order to install and grout. Holes that are in excess of 1/8 inch annular space may not provide correct alignment and will require additional epoxy. The holes are normally drilled

with air driven rotary-percussion drills since it is the quickest and most cost effective method.

These rotary-percussion drills may cause spalling and damage. An example of excessive spalling is shown later on Figure 4-62. If this occurs, rotary core drill may have to be used. This method uses diamond core drills and is not likely to be well received by the contractor. Change in the drilling equipment, technique, or timing will probably be the preferred alternative to prevent the damage. It is critical to align the drills to meet the tolerances. The horizontal alignment is based on the side of the concrete and the vertical alignment is normally aligned to the surface. This is discussed further in dowel alignment paragraphs.

Figure 4-56 Drilling Construction Joint Dowel Holes



Prior to grouting, the holes should be blown clean with oil-free compressed air. The epoxy grout should be mixed (Figure 4-58) just prior to the injection into the back of the hole. Mixing tubes located close to the injection point are normally used. It is critical to inject the epoxy into the back of the hole (Figure 4-59) and the dowel is then inserted as it's rotated to expel any voids. A diagram is shown in Figure 4-60 for the grouting and dowel installation procedure. Buttering the dowel with epoxy and trying to push it into the hole is not acceptable. In some cases, insufficient amounts of grout is injected and applying additional epoxy to the surface, or attempting to re-grout without removing the dowel is not acceptable since it too will entrap air voids around the dowel.

Grout cannot be permitted to drain from the hole (Figure 4-61). If the grout drains out, the bar will have to be cut off flush and replaced adjacent to it. There is no way to adequately replace the epoxy in the hole.

Figure 4-57 Drilled Dowel Installation along Construction Joint



Figure 4.58 Equipment Mixing of Epoxy Grout



Figure 4-59 Injecting Grout in Back of Hole



Figure 4-60 Diagram for Dowel Installation in a Drilled Hole

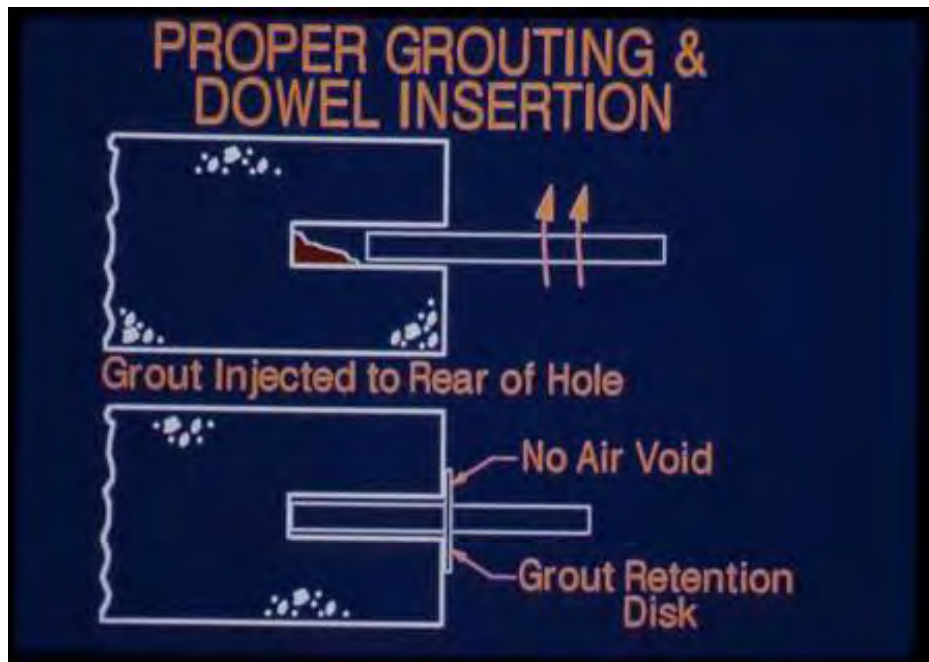

Figure 4-61 Grout Leakage with No Retention Ring



Grout retention rings (Figures 4-62 and 4-63) are required and necessary to retain the epoxy in place while it sets. Retention rings should be available and used in all situations.

Figure 4-62 Dowels with Grout Retention Rings. Note: Excessive Spalling from Drilling in Center Drill Hole



Figure 4-63 Dowel with Retention Ring



Plastic sleeves have been tried on several occasions. They have been inserted in slipform construction and attached to the form in fixed form construction. They have not provided acceptable quality and alignment in any attempt. These plastic sleeves should not be used. Poor alignment is experienced in both types of construction (slip and fixed form) and inadequate consolidation of the concrete is a common problem.

Any suspected problem with grouting or installation should be checked with coring (4-64). Care should be taken to not core directly on the joint line and affect the movement of the joint and seal.

Figure 4-64 Cored Dowel to Verify the Grouting Technique



4-8.11 Dowels in Construction Joint Checklist.

- Dowels drilled or set in forms to the correct alignment and embedment.
- Dowels in forms have grommets to prevent leakage of mortar.
- Drill holes at correct alignment.
- Blowout holes with filtered air prior to injecting epoxy.
- Sufficient amount of epoxy grout injected into back of hole.
- Dowel inserted in a manner to expel all air voids.
- Dowel wiped clean of excessive epoxy grout.
- Excessive epoxy grout wiped smooth on joint face.
- Install grout retention ring.
- Alignment checked after dowel is placed into position.

4-8.12 Alignment of Dowels.

Alignment of dowels can normally be seen easily by looking down the joint (Figure 4-65). In some cases where they all are installed consistently out of alignment it is more difficult to see. Measurements have to be done for horizontal and vertical alignment.

Photo 4-65 Misaligned Dowels



Horizontal measurement for alignment is done with a square (Figure 4-66). For Example: the dowel may be 20 inches long so only 10 inches will be exposed. The tolerance is 1/8/inch per foot so the tolerance for the 10 inch exposed portion is slightly less. The first time to check the alignment is during the drilling of the

holes, then after the dowel is installed, and after the epoxy is hardened. Dowels that are not within tolerances at this time should be cut off and replaced.

Vertical measurement of dowels cannot normally be done with a square like the horizontal measurements. The pavement will normally have a cross slope of 1 to 1-1/2 percent. The tolerance for alignment is 1/8 inch per foot which equates to 1 percent. This would show the dowel out of alignment when using a level or perpendicular to the pavement edge. The best method is to measure the vertical alignment related to the pavement surface. A straightedge has to be used that is long enough to not reflect an edge-slump. The measurement is taken at the end of the dowel and adjacent to the joint face (Figure 4-67). Usually 12 inches of the dowel will not be exposed so the tolerance will have to be adjusted. The dowels that are installed along a joint that is at the crown or swale have to align differently. A level can be used in these situations since two opposite slopes will be involved and the use of a level should be between the two slopes.

Photo 4-66 Checking Dowel for Horizontal Alignment



Figure 4-67 Checking Dowel for Vertical Alignment



A dowel will only allow for slippage if it is properly cleaned and lubricated. Ensure that during construction, the epoxy or mortar does not become bonded on the slip end. It is important that it be cleaned without damaging the paint prior to lubrication. The lubricant should be an oil or light grease. It has to function as a bond breaker, but not so thick that it affects the load transfer capability of the dowel. Globes of grease is not acceptable.

4-8.13 Dowel Alignment Checklist.

- Look down line of dowels for misalignment.
- Use square to check horizontal alignment.
- Use straight-edge on top of concrete to front and back of dowel in relation to a parallel surface to the top of concrete for vertical alignment.
- Use level to check dowel alignment at joints along crowns and swales.
- Assure that contractor adjusts the drill alignment for joints along crowns and swales.

4-8.14 Placement of Tie Bars.

Tie bars are deformed and are used in contraction joints to hold the joint together and provide load transfer through the aggregate interlock at the joint. The use of tie bars, for military airfields is rare but they are typically used at civil airports. Excessive deformed bars passing through the joint will lock it and can cause cracking in the panel. The spacing and size of the bars is important for this

reason. Alignment is also important but not as critical as dowels. When care is not taken in the placement of the bars, ends may appear at the surface and not be effective or cause corrosion and spalling.

4-8.15 Tiebar Checklist.

- Tie bars are of correct size and spacing.
- Tie bars are not coated with a lubrication that would affect bond.
- Tie bars are not corroded excessively where a presence of flakey rust is present.
- Bars are inserted into the correct position and alignment.

4-9 TRANSPORTING CONCRETE.

4-9.1 Introduction.

The transportation of the Portland cement concrete is a factor in the overall quality since it is dependent on a consistent and uniform supply of concrete. The transportation equipment should transport and deliver the concrete to the paver without segregation. Non-agitating trucks should be used on smooth roads where the haul time is less than 15 minutes to avoid segregation during the transportation. Figure 4-68 shows the trucks delayed at the paver.

Figure 4-68 Backup of Trucks at Paving Site



4-9.2 Haul Distance.

The haul distance has to be kept to a minimum so the time limit from batching to placing the concrete is not exceeded. It is also necessary to minimize the number of truckloads that may be on the road at one time and that may have to be wasted when mix adjustments are necessary. Slipform projects should have the plant located on the site so the number of trucks is reduced with the shorter haul distances. The time between the addition of cement and placing the concrete has to also be checked to verify that the concrete can be batched, transported, and placed within the contract time limits.

4-9.3 Equipment.

Truck mixes should never be used for slipform paving. In addition to the mixing difficulties of the low slump mixes, the discharge time and poor mix consistency provides placement problems. Figure 4-69 shows the difficulty in discharging low slump concrete from a mixer truck. Truck mixes can be used for fixed-form placements; however the water in the mix has to be controlled. Sometimes wash water can be in the drum prior to being loaded. It is good practice to have the drums reversed prior to loading to discharge this water.

Figure 4-69 Difficulty in Discharging low Slump Concrete From Truck Mixer



The type and number of trucks transporting the PCC should be reviewed. The transportation has to be coordinated with the plant production, a consistent placing rate, and paver speed, and the round trip time for each truck. The number of trucks and operation is the contractor's responsibility, however; it is appropriate for an inspector to remain aware of the trucking situation and to

determine if the delivery plan is reasonable. The number of trucks can vary depending on factors such as local traffic for the proposed time. It is good practice to drive the proposed route; realizing delivery trucks will have a slower speed.

EXAMPLE: A proposal to pave 37.5 feet wide, 14-inch deep at a rate of 2.6-feet per minute would require 4.2 cubic yards per minute or 250 cubic yards per hour. (Note: The minimum paver speed for slipform paving is 2.5 feet per minute.) If a truck holds 8 cubic yards, 32 trucks per hour would be required. Assume or check a travel time of 17 minutes with a load and 15 minutes return, loading is 6 minutes, and discharge time is 8 minutes. This requires a 45 minute round trip time per truck. The number of trucks required would be $45/60$ times 32 trucks or 24 trucks. This would be a minimum since time and additional trucks are required for refueling or unanticipated breakdowns. Additional trucks may be required if the paver has to wait on concrete delivery, assuming the plant capacity is sufficient.

4-9.4 Transportation Checklist.

- Check plant location and estimated haul time.
- Check time restrictions for anticipated temperatures.
- Check paving rate with delivery capacity and number of trucks.
- Check type of trucks to be used in delivery.
- Check to insure that non-agitating trucks are used for slipform construction method and concrete deposited within 45 minutes after addition of cement. (Note time is reduced to 30 minutes when ambient temperature is above 90 degrees).
- Check to insure that for truck mixers concrete deposited within 90 minutes after addition of cement. (Note time is reduced to 60 minutes when ambient temperature is above 90 degrees.)
- Batch tickets are furnished to the foreman and government.

4-10 DISTRIBUTION AND PLACEMENT OF CONCRETE.

4-10.1 Introduction.

The PCC should be placed as specified and in such a way that neither excessive entrapped air nor segregation occurs as seen in Figures 4-70 and 4-71. To minimize the potential for segregation, the concrete should be placed as close as possible to its final position. The distribution of the concrete in front of the paver is also a factor in the final pavement.

It is necessary to keep the paving machine moving at a steady rate without stops and starts. The base or subbase course has to be protected from contamination and deformation. It is important to use distribution equipment to transfer the

concrete from the trucks to the paving lane. Not having traffic in the lane ahead of the paver allows the dowels and in-pavement light cans (as shown in Figures 4-72 and 4-73) to be accurately placed and maintained without being disturbed. Front end loaders (Figure 4-74) and various types of backhoes have also been used in the past but should be avoided. They do disturb the bases and have even resulted in pockets of base course material being mixed into the concrete section.

Transfer equipment should be self-propelled so it does not affect the paving machine and should evenly distribute the concrete without excessive dropping or causing segregation. Figure 4-75 is a transfer machine that is capable of supporting and moving with a bottom dump truck. Concrete should never be dropped in excess of five feet to avoid segregation of the concrete (Figure 4-76). Trucks should also never be backed down the paving lane, especially through concrete as shown in Figure 4-77.

Figure 4-70 Segregated Concrete with no Coarse Aggregate on Right Side of Core



Figure 4-71 Segregation in Pavement Section



Figure 4-72 Light Cans in Paving Lane



Figure 4-73 Dowel-bar Baskets in Paving Lane



Figure 4-74 Front End Loader Distributing Concrete on Aggregate Base Course



Figure 4-75 Transfer Machine



Figure 4-76 Dropping Concrete in Excess of Five Feet



Figure 4-77 Backing Trucks Down Paving Lane



4-10.2 Placement and Distribution Checklist.

- Pilot lane panels have sufficient strength to carry loads from trucks and distribution machine.
- Transfer machine separate and self-propelled.
- Transfer machine does not segregate the concrete or have an excessive drop (5 feet maximum).
- Concrete placed in a manner to not damage dowel baskets or light cans.
- Concrete is placed to minimize stopping and starting of paver.

4-11 SLIPFORM PAVING.

4-11.1 Introduction.

Slipform paving is a method of concrete placement that uses side forms attached to the paver to confine the concrete and establish a vertical face on the paving lane. The concrete paving mix must be stiff enough to stand unsupported after the side form passes the placed and consolidated concrete.

4-11.2 Equipment.

The slipform paver shall meet the following requirements:

- Weigh at least 2200 lb/foot of lane width.

- Powered by an engine having at least 6.0 horsepower per foot of lane width.
- Equipped with a full width knock-down auger or paddle mechanism, capable of operating in both directions.
- Equipped with immersion vibrators and suitable controls so that all vibrators can be operated at any desired depth within the slab or completely withdrawn from the concrete, as required. More requirements for these vibrators are presented in Section 4-13.
- Equipped with a transversely oscillating screed or an extrusion plate to shape, compact, and smooth the surface.
- Automatically controlled and crawler mounted with padded tracks.
- Spread, consolidate, and shape the plastic concrete to the desired cross section in one pass.

A typical slipform paver is shown on Figure 4-78.

Figure 4-78 Typical Slipform Paver, Showing Vibrators and Knock-Down Auger (Note Unstable Base Course Under the Right Tracks of the Paver)



4-11.3 Execution.

4-11.3.1 Preparation for Paving.

The following items shall be inspected and approved prior to commencing paving operations:

Preliminary considerations:

- All required documentation for materials, proportioning, batch plant inspection and calibration, and uniformity testing shall be submitted and approved.
- Adequate materials shall be on hand to meet the proposed PCC production.
- A suitable number of trucks shall be available to transport PCC without interruption of the paving operation.
- When windy conditions during paving appear probable, equipment and material shall be at the paving site to provide windbreaks, shading, fogging, or other action to prevent plastic shrinkage cracking or other damaging drying of the concrete.

The base course underlying the PCC shall meet the following requirements:

- Underlying material, upon which concrete is to be placed shall be clean, damp, and free from debris, waste concrete or cement, frost, ice, and standing or running water.
- Prior to placement of concrete, the underlying material shall be well drained and shall have been satisfactorily graded by string-line controlled, automated, trimmer/fine grader and uniformly compacted in accordance with the applicable specification provisions.
- The surface of the underlying material shall be tested as to crown, elevation, and density.
- Any underlying material disturbed by construction operations shall be reworked and recompact to specified density.
- The same underlying material under the paving lane shall be continued beyond the edge of the lane a sufficient distance and shall be thoroughly compacted and true to grade to provide a suitable trackline for the slipform paver and firm support for the edge of the paving lane. See Figure 4-78.

String lines for grade control shall meet the following requirements:

- Accurately and securely install string lines well in advance of concrete placement. Provide supports at necessary intervals to eliminate all sag in the string line when properly tightened.
- The string line shall be high strength wire set with sufficient tension to remove all sag between supports.
- Supports shall be securely staked to the underlying material or other provisions made to ensure that the supports will not be displaced when the string line is tightened or when the string line or supports are accidentally touched by workmen or equipment during construction.
- The appliances (aka, whisker poles) for attaching the string line to the supports shall be capable of easy adjustment in both the horizontal and vertical directions.

- When it is necessary to leave gaps in the string line to permit equipment to use or cross underlying material, provisions shall be made for quickly and accurately replacing the string line without any delay to the forward progress of the paver. Supports on either side of the gap shall be secured in such a manner as to avoid disturbing the remainder of the string line when the portion across the gap is positioned and tightened. The string line across the gap and adjacent to the gap for a distance of 200 feet shall be checked for horizontal and vertical alignment after the string line across the gap is tightened.
- Vertical and horizontal positioning of the string line shall be such that the finished pavement shall conform to the alignment and grade elevations shown on the drawings within the specified tolerances for grade and smoothness. The string line shall be set true to line and grade.
- For pilot lanes, string lines are required on both sides of the paving lane for transverse grade control. Control from a slope-adjustment control or control operating from the underlying material shall never be used.

A typical string line layout is shown on Figure 4-79.

Figure 4-79 Typical String Line Alignment, Showing, Supports, Whisker Poles, and String Line



4-11.3.2 Paving.

The slipform paver shall shape the concrete to the specified and indicated cross section, meeting all tolerances, in one pass. The slipform paver shall finish the surface and edges so that only a very minimum isolated amount of hand finishing is required. Finishing operations are discussed in Section 4-14. Side forms on slipform pavers shall be properly adjusted so that the finished edge of the paving lane meets all specified tolerances.

The paver shall operate in a continuous manner and at a speed of not less than 2.5 feet per minute. An adequate number of trucks should be transporting fresh PCC to the paver to maintain forward progress. Stopping and starting the paver will lead to surface smoothness issues.

If the paving operation does not meet the above requirements and the specified tolerances, the operation shall be immediately stopped, and the Contractor shall regroup and replace or modify any equipment as necessary, modify paving procedures or modify the concrete mix, in order to resolve the problem.

4-11.4 Common Problems.

Problems that occur during slipform paving are generally caused by a combination of the paver and the properties of the concrete mix. Problems commonly encountered may be related to the paver setup and operation, the concrete mix, or a combination of both.

4-11.4.1 Poor Consolidation.

Poor consolidation may be encountered on the vertical face or horizontal surface of the slab.

On the vertical face (Figure 4-80), the problem is most commonly related to a lack of vibration. Either the outside vibrator is too far from the slab edge or the vibrator is not working. The specifications limit the spacing of this outer vibrator to a maximum of 12 inches from the lane edge. There is a tendency to keep this spacing as large as possible to prevent the vibration from collapsing the vertical face. Vibrator frequency and amplitude have been discussed earlier in this Section. A vibrator can be tested using CRD-C 521.

Figure 4-80 Poor Consolidation of Vertical Face of Slab



On the horizontal surface (Figure 4-81), the problem may be related to either the mix design or the paver extrusion plate. In most cases, the combined gradation is deficient on the U.S. standard sieve #4 and/or #8, leading to a rough and open surface. If a manufactured fine aggregate is used in the mix, small tears in the surface will be observed where the crushed faces of the fine aggregates get snagged and pulled out.

Figure 4-81 Poor Consolidation on Horizontal Surface of Slab



4-11.4.2 Edge Slump.

Edge slump can be present on the upper edges of a pilot lane (Figure 4-82). If not repaired while the concrete is fresh, the adjacent fill-in lane placement against the slumped pilot lane will result in a swale which can affect aircraft directional stability and create a life-safety issue.

Edge slump can be caused by either mix proportions or equipment, or a combination of both. If the problem occurs only on one side of the paved lane (Figure 4-83), the paver needs to be adjusted, since the mix is the same across the slab. Check the paver for:

- Operation of the knock-down auger (to avoid segregation of the mix).
- Outside vibrator location and vibration frequency/amplitude.
- Overbuild on the paver extrusion screed (Figure 4-84).

Figure 4-82 Edge Slump

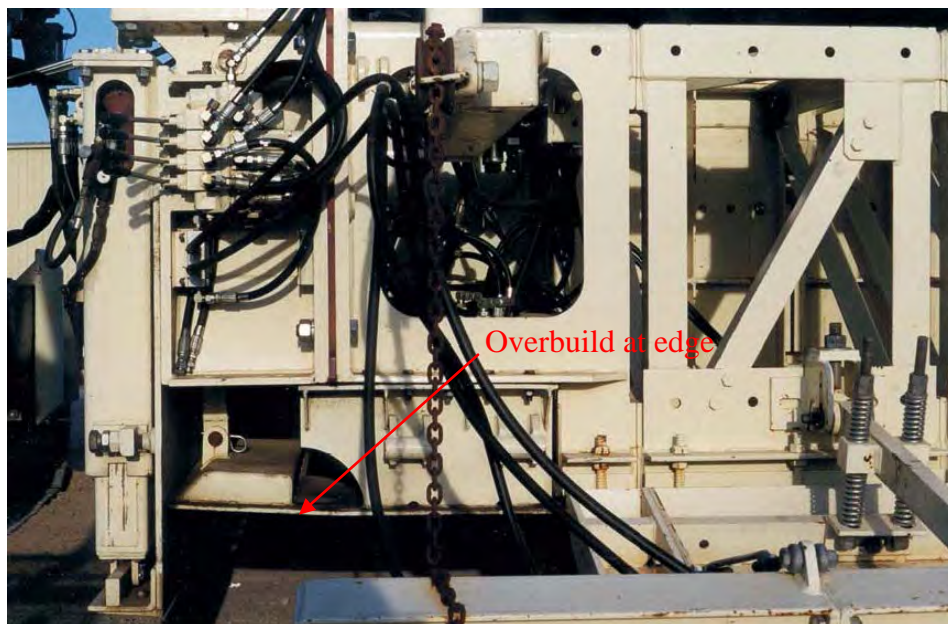

Figure 4-83 Torn and Slumped Edge on Right, Good Edge on Left. Problem is Paver Adjustment



If the problem occurs on both sides of the paved lane, the problem could be paver or mix related. Check the paver as described above. Check the coarseness (CF) and workability (WF) factors to see that the combined gradation is suitable for slipform paving (Section 4-4).

Figure 4-84 Overbuild On Outer Edge of Paver Extrusion Plate.



Edge slump is best repaired before the concrete has set. Use the following method as shown on Figure 4-85:

- Set a full-depth steel form against the vertical face of the slumped edge. Without full-face support, the subsequent vibration will collapse the entire face.
- Obtain fresh concrete from in front of the paver. Do not discard the large aggregate and do not use only the mortar (fine aggregate, cement and water) portion of the mix.
- Place the concrete in the slumped area.
- Vibrate the new concrete into the underlying slab using a hand-held vibrator. Do not screed the large pieces out of the mix.
- Use a bridge to place and vibrate in the slab interior. Do not walk on the fresh concrete.
- Strike off the surface flush with the supporting form.
- Leave forms in place for a minimum of 12 hours. Spray curing compound on face after the forms are removed.

Figure 4-85 Acceptable Repair of Edge Slump



NOTE: At times the edges are rebuilt using a 2x6 guide and plastering on a mortar mix, as shown on Figure 4-86. This is bad practice. **Do not permit this method of repair.**

Figure 4-86 Unacceptable Repair of Edge Slump. No Full-Depth Face Support, So Vibration is Impossible



4-11.4.3 Rough or Torn Edges.

Rough or torn edges are shown on Figure 4-83. Check the same paver issues as identified for edge slump. In this case, vibration could be inadequate. Check the coarseness (CF) and workability (WF) factors to see that the combined gradation is suitable for slipform paving (Section 4-4).

4-11.4.4 Open or “Vuggy” Surface.

Open or vuggy surfaces are shown on Figures 4-81 and 4-82. The most likely cause is a mix deficient in U.S. standard sieve #4 and #8 sizes. Mixes using a manufactured fine aggregate may also exhibit pull-out and tearing of the smaller size aggregate pieces.

4-11.5 Compliance Checklist

- Plant inspected and calibrated.
- Adequate materials on hand for proposed construction.
- Adequate trucks are available to deliver fresh concrete to paver.
- Base course compacted, to grade, and free of ruts.
- Width of base course is adequate to support paver.
- String lines set to grade and taut.
- Paver inspected and vibrators calibrated.
- Spare vibrators on hand.
- Full-depth forms, bridges, and hand vibrators available for repairing edge slump.
- Paver is moving continuously.
- Adjustments to paver or mix are made as conditions require. One person on the Contractor's staff should be identified with this responsibility.

4-12 FIXED FORM PAVING.

4-12.1 Introduction.

Fixed form paving is a method of concrete placement that uses full depth, steel forms staked to the underlying base course to establish line and grade.

4-12.2 Form Requirements.

Forms for paving operations:

- Straight forms shall be made of steel and shall be furnished in sections not less than 10 feet in length.
- Flexible or curved forms of proper radius shall be used for curves of 100-foot radius or less.
- Wood forms for curves and fillets shall be made of well-seasoned, surfaced plank or plywood, straight, and free from warp or bend. Wood forms shall be adequate in strength and rigidly braced.
- Forms shall have a depth equal to the pavement thickness at the edge.
 - Where the project requires several different slab thicknesses, forms may be built up by bolting or welding a tubular metal section or by bolting wood planks to the bottom of the form to completely cover the underside of the base of the form and provide an increase in depth of not more than 25 percent.
 - The base width of the one-piece or built-up form shall be not less than eight-tenths of the vertical height of the form, except that forms 8 inches or less in vertical height shall have a base width not less than the vertical height of the form.

- Maximum vertical deviation of top of any side form, including joints, shall not vary from a true plane more than 1/8 inch in 10 feet, and the upstanding leg shall not vary more than 1/4 inch.
- Forms shall be provided with adequate devices for secure settings so that when in place they will withstand, without visible spring or settlement, the impact and vibration of the consolidating and finishing equipment.

A typical steel form segment is shown on Figure 4-87.

Figure 4-87 Fixed Form. Note Hole for Dowels in Middle of Form Face



Forms placement and anchorage:

- Tightly lock form sections together so that they are free from play or movement in any direction.
- Set forms for full bearing on foundation for entire length and width and in alignment with edge of finished pavement.
- Support forms during entire operation of placing, consolidating, and finishing so that forms will not deviate vertically more than 0.01 foot from required grade and elevations indicated.
- Check conformance to the alignment and grade elevations shown on the drawings. Make necessary corrections immediately prior to placing the concrete.
- Clean and oil the forms each time before concrete is placed.
- Do not place concrete until setting of forms has been checked and approved by the CQC team.

- Anchor forms for overlay pavements and for other locations where forms must be set on existing pavements with stakes or by other approved methods. Holes in existing pavements for form stakes shall be carefully drilled by methods which will not crack or spall the existing pavement. After use, the holes shall be filled flush with the surrounding surface using approved material, prior to overlying materials being placed.
- Discontinue any method which does not hold the form securely or which damages the existing pavement.
- Demonstrate the proposed form setting procedures at an approved location prior to setting forms for paving operations.

Form removal:

- Keep forms in place at least 12 hours after the concrete has been placed.
- When conditions are such that the early strength gain of the concrete is delayed, leave the forms in place for a longer time, as directed.
- Remove forms by procedures that do not damage the concrete. Bars or heavy metal tools shall not be used directly against the concrete in removing the forms.
- If dowels are set through the forms, carefully remove the forms without damaging the dowels. If a dowel was bent or mis-aligned during the concrete placement operation, that dowel shall be sawn off to remove the form. Re-drill and epoxy a replacement dowel after the form is removed.
- Spray all exposed surfaces with curing compound.
- Any concrete found to be defective after form removal shall be repaired promptly.

4-12.3 Paver Types.

4-12.3.1 Slipform Pavers. Slipform pavers place concrete inside fixed forms by sliding the mud box along the top of the form. This is the same slipform technique used to pave a fill-in lane between two pilot lanes. A skid plate is sometimes used to align the paver with the top of the form. Grades are controlled by the top of the fixed forms. See Figure 4-88.

4-12.3.2 Form Riding Pavers. Form riding pavers are not that common in CONUS projects, but may be encountered in OCONUS projects. These pavers ride on the top of the forms. Each form section is capped with a rail to provide alignment control.

A form riding paver is equipped with a knock-down plow or auger, vibrators and extrusion plate. The criteria for these components are the same as described for a slipform paver in Section 4-11. A British form riding paver is shown on Figure 4-89.

Figure 4-88 Slipform Paver Placing Concrete Inside Fixed Forms (Note Curved Skid Plate on Paver Mud Box. Also Note the Forms are Built Up With Cribbing. This is Unacceptable)



4-12.3.3 Truss-Mounted Pavers. The truss-mounted paver is an update to a bridge deck paver. The bridge deck paver was developed to place relatively thin (8 inches maximum) overlays on bridges. The airport pavers were developed from this design to place thicker, stiffer paving mixes.

These pavers use a truss frame riding on a guiderail system outside the forms. The frame moves longitudinally down the paving lane, while a truss-mounted carriage moves transversely across the lane and knocks down, consolidates and finishes the concrete. The frame can be lengthened to place multiple lanes in a single pass, provided adequate concrete is available to keep the paver moving. These pavers are often used in congested areas adjacent to structures or for apron construction.

The truss-mounted carriage typically carries a small auger to knock-down the paving mix, one or two rotating drums to smooth and compact the surface, and two vibrators, each vibrating in an alternating pattern. When the carriage gets close to the inside edge of the form, the first vibrator stops and lifts out of the concrete; the carriage reverses direction; and the second vibrator is inserted and starts vibrating. This alternating sequence continues across the slab as the truss frame moves longitudinally down the paving lane. A typical truss-mounted paver is shown on Figure 4-90.

Figure 4-89 British Form-Riding Paver. Note Rail Section on Top of Forms



4-12.4 Accessories.

4-12.4.1 Hand Vibrators. Hand vibrators may be required to supplement the vibration from the carriage-mounted vibrators. If the paver is not adjusted correctly, the vibrators may be lifted and inserted short of the side forms. This is particularly true when dowels are set in the forms. This will leave a zone of unconsolidated, honeycombed concrete at the edge of the slab where loads are transferred across the dowels to the adjacent slab. Supplemental hand vibration is required in these areas.

4-12.4.2 Bridges. Bridges are required to provide access for consolidating, patching, or repairing fresh concrete beyond the reach of the workmen outside the forms. Do not permit workmen to walk in fresh concrete.

4-12.5 Execution.

Preparation for Paving. Identified items shall be inspected and approved prior to commencing paving operations. Preliminary considerations include:

- All required documentation for materials, proportioning, batch plant inspection and calibration, and uniformity testing shall be submitted and approved.
- Adequate materials shall be on hand to meet the proposed PCC production.

- A suitable number of trucks shall be available to transport PCC without interruption of the paving operation.
- When windy conditions during paving appear probable, equipment and material shall be at the paving site to provide windbreaks, shading, fogging, or other action to prevent plastic shrinkage cracking or other damaging drying of the concrete.

Figure 4-90 Truss-Mounted Paver and Carriage. Paver is Moving from right to left



The base course underlying the PCC shall meet the following requirements:

- Underlying material, upon which concrete is to be placed shall be clean, damp, and free from debris, waste concrete or cement, frost, ice, and standing or running water.
- Prior to placement of concrete, the underlying material shall be well drained and shall have been satisfactorily graded by string-line controlled, automated, trimmer/fine grader and uniformly compacted in accordance with the applicable specification provisions.
- The surface of the underlying material shall be tested as to crown, elevation, and density.
- Any underlying material disturbed by construction operations shall be reworked and recompact to specified density.

The forms installation shall meet the following requirements:

- Founded on compacted base course and flush with base course surface.
- Anchored with a minimum of three forms stakes per 10-foot section.
- Dowels (if used) anchored in forms.
- Cleaned and oiled.
- Set to grade.

4-12.5.1 Paving.

The paver-finisher, and its gang-mounted vibrators, together with its operating procedures shall be adjusted and operated and coordinated with the concrete mixture being used to produce a thoroughly consolidated slab throughout, true to line and grade within specified tolerances.

The paver-finishing operation shall produce a surface finish free of irregularities, tears, voids of any kind, and any other discontinuities. The paver-finisher shall make only one pass across the pavement; multiple passes will not be permitted. The equipment and its operation shall produce a finished surface requiring no hand finishing other than the use of cutting straightedges, except in very infrequent instances.

4-12.6 Common Problems.

Fixed form paving eliminates concerns with edge slump and mix design interaction; however, several common problems are related to fixed form paving operations.

4-12.6.1 Poor consolidation. Poor consolidation can occur in fixed form paving operations due to inadequate internal vibration of thicker, lower-slump airfield pavement mixes. This problem is commonly observed on the vertical face of the slab, where the vibrator is retracted short of the side forms (especially if dowels are present). See Figure 4-91. However, this problem could also occur within the slab.

Obtain cores from the slab interior to confirm consolidation of the slab. Adjust the vibrators per manufacturer's recommendations and provide supplemental hand vibration to eliminate the problem.

4-12.6.2 Open or "Vuggy" Surface. Open or vuggy surfaces are shown on Figure 4-92. The most likely cause is a mix deficient in U.S. standard sieve #4 and #8 sizes. Mixes using a manufactured fine aggregate may also exhibit pull-out and tearing of the smaller size aggregate pieces.

Figure 4-91 Unconsolidated Concrete Due to Lack of Vibration at Slab Edge



Figure 4-92 Torn Surface (Mix Was Deficient in #4 and #8 Aggregate Sizes)



4-12.6.3 Pasty Surface. A pasty surface is often caused by a high-slump concrete mix. The rotating drums on the truss-mounted carriage churn the surface mortar into a thick, non-durable paste, which will eventually spall off the surface (Figure 4-93). A maximum paste thickness of 1/8 inch is permissible. Adjust the paver rotating drum to decrease the surface agitation and adjust the mix design.

Figure 4-93 Excess Paste on Surface



4-12.7 Compliance Checklist.

- Plant inspected and calibrated,
- Adequate materials on hand for proposed construction.
- Adequate trucks are available to deliver fresh concrete to paver.
- Base course compacted, to grade, and free of ruts.
- Forms set to grade and stable.
- Paver inspected and vibrators calibrated.
- Hand vibrators and bridges on hand.
- Paver is moving continuously.
- Adjustments to paver or mix are made as conditions require. One person on the Contractor's staff should be identified with this responsibility.

4-13 CONSOLIDATION.

4-13.1 Introduction.

When low-slump concrete is deposited in the form, it is in a honeycombed condition, consisting of mortar-coated, coarse-aggregate particles and irregularly distributed pockets of entrapped air. If allowed to harden in this condition, the concrete will have low strength, high permeability, and poor resistance to deterioration. It may also have a poor appearance. Consolidation is the process of inducing a closer arrangement of the solid particles in freshly mixed concrete or mortar during placement by the reduction of voids, usually by vibration,

centrifugation (spinning), rodding, spading, tamping, or some combination of these actions.

All pavements should be consolidated by full-width vibration. The type of vibration, internal or surface, is determined by the slab thickness, the rate of production, consistency, and other characteristics of the concrete mixture. Internal vibrators, usually gang-mounted spud vibrators, should be used when pavement thicknesses are 8 inches or more.

A more thorough discussion of consolidation is provided in ACI 309R-05.

4-13.2 Vibrators.

4-13.2.1 Immersion Vibrators. The paver shall be equipped with immersion vibrators and suitable controls so that all vibrators can be operated at any desired depth within the slab or completely withdrawn from the concrete, as required. See Figure 4-78 for a typical example.

- The spacing of the immersion vibrators across the paving lane shall not exceed 30 inches.
- The outside vibrators shall not be more than 12 inches from the lane edge.
- Spud vibrators shall operate at a frequency of not less than 8000 impulses/minute and an amplitude of not less than 0.03 inch
- Tube vibrators shall operate at a frequency of not less than 5000 impulses/minute and amplitude of not less than 0.03 inch.

4-13.2.2 Surface Vibrators. Surface vibrators may be used for pavements less than 8 in. thick. Most pavers for airfield pavement work are equipped with a transversely oscillating screed or an extrusion plate to shape, compact, and smooth the surface, so additional surface vibration is not required. Clary screeds or rotating tube floats are not permitted because they can bring excess fine material to the surface (see Figure 4-93).

A small vibratory screed is shown on Figure 4-94. Note use of supplemental hand vibration. Workmen should be operating from a lane-spanning bridge, not standing in the fresh concrete.

4-13.2.3 Hand-Held Vibrators. Hand-held vibrators shall be used only for supplemental consolidation. They should not be the primary source of vibration for airfield pavement concrete, other than for small, odd-shaped areas where hand-placement is a necessity. A typical hand-held pneumatic vibrator is shown on figure 4-95. These vibrators are also available with gasoline engine or electric power.

The hand held vibrators shall meet the following requirements (ACI, 2005):

- Minimum head diameter - 2 inches.
- Radius of influence - 7 to 14 inches.
- Vibration frequency - as noted in paragraph 14.2.1.
- Vibration amplitude - as noted in paragraph 14.2.1.

Figure 4-94 Small Vibratory Screed



Figure 4-95 Hand-Held, Pneumatic Vibrator



4-13.2.4 Calibration. All vibrators must be calibrated for vibration frequency and amplitude. The test methods are presented in CRD-C 521. A typical vibration tachometer and stick-on amplitude gage are shown on Figures 4-97 and 4-98.

Figure 4-97 Tachometer for Measuring Vibrator Frequency



Figure 4-98 Optical Wedge Sicker for Measuring Vibrator Amplitude

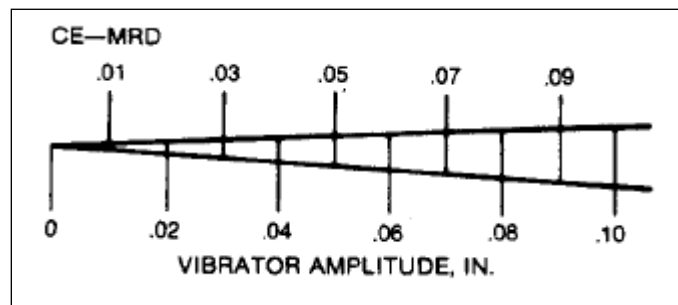

Spare vibrators and parts shall be on hand prior to starting concrete placement.

4-13.3 Execution.

Concrete shall be consolidated with the specified type of lane-spanning, gang-mounted, mechanical, immersion type vibrating equipment mounted in front of the paver, supplemented, in rare instances as specified, by hand-operated vibrators. For each paving train, at least one additional vibrator spud, or sufficient parts for rapid replacement and repair of vibrators shall be maintained at the paving site at all times.

The vibrators shall be inserted into the concrete to a depth that will provide the best full-depth consolidation but not closer to the underlying material than 2 inches. Excessive vibration shall not be permitted.

If the vibrators cause visible tracking in the paving lane (Figure 4-99), the paving operation shall be stopped and equipment and operations modified to prevent it.

Figure 4-99 Vibrator Trails (Note Uniform Spacing Corresponding to Vibrator Spacing)



Concrete in small, odd-shaped slabs or in isolated locations inaccessible to the gang-mounted vibration equipment shall be vibrated with an approved hand-operated immersion vibrator operated from a bridge spanning the area. Vibrators shall not be used to transport or spread the concrete. Hand-operated vibrators shall not be operated in the concrete at one location for more than 20 seconds. Insertion locations for hand-operated vibrators shall be between 6 to 15 inches on centers.

4-13.4 Common Problems.

Common problems due to inadequate consolidation ((honeycomb along the edges, large air pockets, or any other evidence) have been discussed in Sections 4-11 and 4-12.

A common problem associated with over consolidation is segregation. The excessive vibration causes the concrete to segregate, with the heavier large size aggregate sinking and the lighter, fine aggregate and mortar floating to the top. This can be detected by observing the outer edges of pilot lanes (Figure 4-100) or by obtaining cores through the slab (Figure 4-101).

Figure 4-100 Segregation on Slab Face



Figure 4-101 Cores Illustrating Segregation from Over Vibration (Core on Left Was Taken Along Vibrator Alignment, While the Core on the Right Was Taken Between the Vibrators. Vibration Frequency = 12,000 VPM.)



4-13.5 Compliance Checklist.

- Paver vibrators:
 - Set at correct spacing.
 - Frequency and amplitude checked and adjusted.
 - Depth not closer than 2 inches to underlying layer.
 - Spare vibrators and/or parts on-hand.
- Hand-held vibrators:
 - Head diameter, frequency and amplitude checked and adjusted.
 - Lane-spanning bridges on-hand.

4-14 FINISHING, TEXTURING AND EDGING.

4-14.1 Introduction.

Finishing, texturing and edging are the sequence of final operations on the fresh concrete pavement. The sequence of operations shall be transverse finishing, longitudinal machine floating if used, straightedge finishing, texturing, and then edging of joints. The purpose of these operations is to provide a dense, durable pavement surface with adequate friction resistance.

4-14.2 Finishing.

Finishing operations shall be a continuing part of placing operations starting immediately behind the strike-off of the paver.

4-14.2.1 Equipment.

4-14.2.1.1 **Paver.** Paver should be equipped with a transversely oscillating screed or an extrusion plate to shape, consolidate, and smooth the surface.

4-14.2.1.2 **Longitudinal mechanical float.** Longitudinal mechanical float should be specially designed and manufactured to smooth and finish the pavement surface without working excess paste to the surface. It shall be rigidly attached to the rear of the paver-finisher or to a separate self-propelled frame spanning the paving lane. The float plate shall be at least 5 feet long by 8 inches wide and shall automatically oscillate in the longitudinal direction while slowly moving from edge to edge of the paving lane, with the float plate in contact with the surface at all times. See Figures 4-102 and 4-103.

Figure 4-102 Longitudinal Float Behind Slipform Paver



Figure 4-103 Float Pans Behind Truss-Mounted Paver



4-14.2.1.3 Pipe float. Pipe floats are not recommended since they tend to overwork the surface and cause a buildup of weak paste. Pipe float, if used, shall be a non-rotating pipe 6 to 10 inches in diameter and sufficiently long to

span the full paving width when oriented at an angle of approximately 60 degrees with the centerline. The pipe float shall be mounted on a self-propelled frame that spans the paving lane. No means of applying water to the surface shall be incorporated in the pipe float. See Figure 4-104.



Figure 4-104 Pipe Float

4-14.2.1.4 Clary screeds. Clary screeds, other rotating tube floats, or bridge deck finishers shall not be allowed on mainline paving. Vibrating screeds or pans shall be used only for isolated slabs where hand finishing is permitted as specified, and only where specifically approved.

4-14.2.1.5 Hand finishing equipment. Cutting straight edge shall be 12 feet in length and shall be operated from the sides of the pavement and from bridges. A straightedge operated from the side of the pavement shall be equipped with a handle 3 feet longer than one-half the width of the pavement. Finishing equipment and tools shall be maintained clean and in an approved condition. Bull-floats are not permitted, except in isolated instances. Bull floats (Figure 4-105) tend to produce a pasty, non-durable surface.

4-14.2.2 Execution

Initial finishing shall be provided by the transverse screed or extrusion plate on the paver.

4-14.2.2.1 Finishing. Finishing shall be by the machine method. Any machine finishing operation which requires appreciable hand finishing, other than a moderate amount of straightedge finishing, shall be immediately stopped and proper adjustments made or the equipment replaced.

Figure 4-105 Hand Finishing Tools

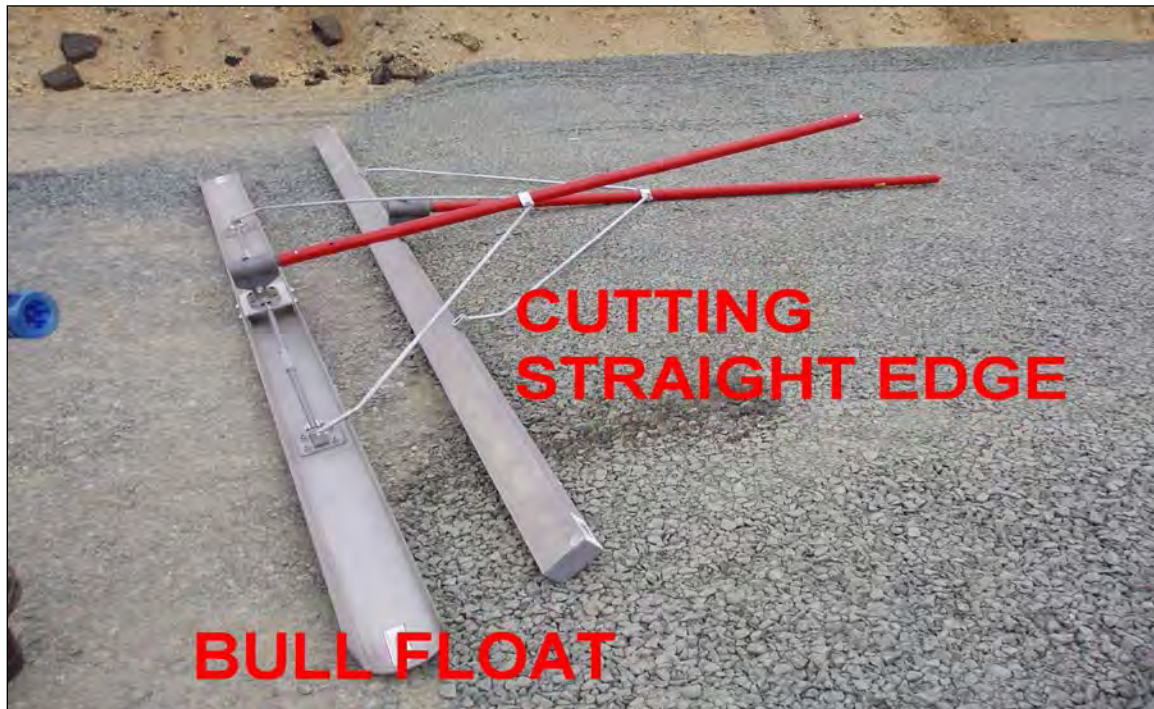

4-14.2.2.2 **Mortar rich surface.** Any operations which produce more 1/8 inch of mortar-rich surface (defined as deficient in plus U.S. No. 4 sieve size aggregate) shall be halted immediately and the equipment, mixture, or procedures modified as necessary.

4-14.2.2.3 **Compensation for low spots.** Compensation shall be made for surging behind the screeds or extrusion plate and settlement during hardening and care shall be taken to ensure that paving and finishing machines are properly adjusted so that the finished surface of the concrete (not just the cutting edges of the screeds) will be at the required line and grade

4-14.2.2.4 **Addition of water.** At no time shall water be added to the surface of the slab with the finishing equipment or tools, or in any other way, except for fog (mist) sprays specified to prevent plastic shrinkage cracking.

4-14.2.2.5 **Supplemental hand finishing.** Supplemental hand finishing for machine finished pavement shall be kept to an absolute minimum

4-14.2.2.6 **Excessive slurry or paste.** If there is concrete slurry or fluid paste on the surface that runs over the edge of the pavement, the paving operation shall be immediately stopped and the equipment, mixture, or operation modified to prevent formation of such slurry. Any slurry which does run down the vertical edges shall be immediately removed by hand, using stiff brushes or scrapers.

4-14.2.2.7 **Edge slump compensation.** No slurry, concrete or concrete mortar

shall be used to build up along the edges of the pavement to compensate for excessive edge slump, either while the concrete is plastic or after it hardens.

4-14.2.2.8 Straightedging. Minor irregularities and score marks in the pavement surface shall be eliminated by means of cutting straightedges. Note in Figure 4-106 how the cutting straightedge smoothes out the score marks left by the longitudinal float. Long-handled, flat bull floats shall be used very sparingly and only as necessary to correct minor, scattered surface defects. If frequent use of bull floats is necessary, the paving operation shall be stopped and the equipment, mixture or procedures adjusted to eliminate the surface defects. The surface finish of the pavement shall be produced essentially by the finishing machine and not by subsequent hand finishing operations. All hand finishing operations shall be subject to approval and shall be modified when directed.

Figure 4-106 Cutting Straightedge



4-13.3 Texturing

Only burlap drag or broom finishes are permitted on airfield pavement concrete (Figures 4-107 and 4-108). Artificial turf drag and wire tining are not permitted.

Grooving is required on runway pavements to increase friction and decrease hydroplaning potential. Grooves shall be cut into the hardened pavement surface using a diamond-blade grooving machine manufactured for this purpose.

Figure 4-107 Broom Texture



Figure 4-108 Burlap Drag Texture



Grooving is required on runway pavements to increase friction and decrease hydroplaning potential. Grooves shall be cut into the hardened pavement surface using a diamond-blade grooving machine manufactured for this purpose.

4-14.3.1 Equipment.

4-14.3.1.1 Burlap Drag. A burlap drag shall be securely attached to a separate wheel mounted frame spanning the paving lane or to one of the other similar pieces of equipment. Length of the material shall provide 24 to 36 inches dragging flat on the pavement surface. Width shall be at least equal to the width of the slab. The material shall be clean, reasonably new burlap, completely saturated with water before attachment to the frame, always resaturated before start of use, and kept clean and saturated during use. Burlap shall conform to AASHTO M 182, Class 3 or 4.

4-14.3.1.2 Broom. Surface texture shall be applied using an approved mechanical stiff bristle broom drag of a type that will uniformly score the surface transverse to the pavement center line. The broom shall be capable of traversing the full width of the pavement in a single pass at a uniform speed and with a uniform pressure. The scores shall be uniform in appearance and approximately 1/16 inch in depth but not more than 1/8 inch in depth.

4-14.3.2 Execution

The burlap drag surface texture shall be applied by dragging the surface of the pavement, in the direction of the concrete placement, with an approved burlap drag. The drag shall be operated with the fabric moist, and the fabric shall be cleaned or changed as required to keep clean. The dragging shall be done so as to produce a uniform finished surface having a fine sandy texture without disfiguring marks. See Figure 4-109.

Figure 4-109 Burlap Drag Texture Applied From Hand Operated Bridge.



Broomed surface texture shall be applied using an approved mechanical stiff bristle broom drag. Successive passes of the broom shall be overlapped the minimum necessary to obtain a uniformly textured surface. Brooms shall be

washed thoroughly at frequent intervals during use. Worn or damaged brooms shall be removed from the job site. Brooming should be completed before the concrete has hardened to the point where the surface will be unduly torn or roughened, but after hardening has progressed enough so that the mortar will not flow and reduce the sharpness of the scores. Hand brooming will be permitted only on isolated odd shaped slabs or slabs where hand finishing is permitted. For hand brooming, the brooms shall have handles longer than half the width of slab to be finished. The hand brooms shall be drawn transversely across the surface from the center line to each edge with slight overlapping strokes. See Figure 4-110.

Figure 4-110 Broom Texturing Equipment



4-13.4 Edging

After texturing has been completed, the edge of the slabs along the forms, along the edges of slipformed lanes, and at the joints shall be carefully finished with an edging tool to form a smooth rounded surface of 1/8 inch radius (Figure 4-111). No water shall be added to the surface during edging. Extreme care shall be taken to prevent overworking the concrete. The lanes on both sides of the longitudinal joint should be edged to provide a groove for aligning the joint reservoir sawing operation and prevent spalling.

Figure 4-111 Edging A Fill-In Lane



4-14.5 Common Problems

4-14.5.1 Overfinishing

Overfinishing is one of the most common problems encountered on PCC airfield pavement construction. Overfinishing causes a pasty, high water-cement ratio finish, which is susceptible to abrasion and freezing and thawing damage. Overfinishing is related to finishing procedures and/or to the mix design.

Excessive use of bull floats is the primary procedural cause. A bull float works the concrete mortar to the surface and provides a sandy surface (like a residential sidewalk or driveway) which is deceiving.

The mix may be gap-graded, in which case the voids in the mix are filled with excessive mortar. The use of the CF, WF, and workability box (Chapter 5) can help identify the problem and the solution.

4-14.5.2 Not Edging

Not edging both sides of the longitudinal joints can lead to spalling of the joint when the joint reservoir is sawed (Figure 4-112). Since the concrete has hardened, the only solution is to repair the spalled areas (Section 4-20).

Figure 4-112 Unedged Longitudinal Joint



4-14.6 Compliance Checklist

- Finishing:
 - Equipment clean and ready for use.
 - Cutting straightedges are on hand.
 - Limited use of bull float.
 - Surface paste not thicker than 1/8 inch.
- Texturing:
 - Equipment clean and ready for use.
 - Burlap drag is clean and damp.
 - Burlap drag covers entire lane width and lays flat on surface for 24-36 inches.
- Edging:
 - Edging tool with 1/8 inch radius is available.
 - Longitudinal joint is edged, both sides.

4-15 CURING AND PAVEMENT PROTECTION.

4-15.1 Introduction.

The concrete pavement has to be continuously protected against loss of moisture and rapid temperature changes for the 7 day cure period. A minimum temperature has to be maintained for cold weather in order to achieve strength gain for the cure period. Protection from rain, equipment, and traffic loading is also important and required.

4-15.2 Curing.

Curing of the concrete consists of maintaining adequate moisture for the cement hydration and strength gain of the concrete. The strength of the in place concrete should not be confused with the samples that are cured in the laboratory. The samples are cured in ideal conditions, not exposed to the elements like the pavement. It is critical that the moisture and temperature be maintained for strength gain. The two methods for curing are membrane curing and moist curing.

The equipment needed for curing and protection of the concrete has to be on hand and ready for use before concrete placement begins. If a method of curing does not provide proper cure, the affected pavement has to be removed and replaced, and another method of curing has to be employed.

4-15.2.1 Membrane Curing. Membrane curing (Figure 4-113) is the most common method used. A uniform coating of white-pigmented, membrane-forming, curing compound is applied to the entire exposed surface of the concrete as soon as the free water has disappeared. The white compound is easy to visually see for coverage and reflects heat from the sun. CRD-C 300 is used and is more restrictive in the water retention than the common ASTM C-309. The formed edge faces have to have curing compound applied as soon as the forms are removed. If the forms are released and not removed moist curing method should be used since the concrete cannot be allowed to dry. If any drying on any surface has occurred, the concrete has to be moistened with a fine spray of water, and curing compound applied by means of an approved automatic spraying machine. It is important to have a wind screen protecting the nozzles as shown in Figure 4-114.

The curing compound is required to be applied with overlapping coverage, single coat or a two-coat application. The nozzles on the spray machines can be adjusted normally to provide an overlapping spray. For a two coat application, each pass is to provide a coverage rate of 400 square feet per gallon, plus or minus 5.0 percent. If the curing compound is applied with a single overlapping application, a uniform coverage rate of 200 square feet per gallon can be used. The application of curing compound by hand-operated, mechanical powered pressure sprayers will be permitted only on odd widths or shapes of slabs and on concrete surfaces exposed by the removal of forms. When the application is made by hand-operated sprayers, a second coat has to be applied in a direction approximately at right angles to the direction of the first coat. If pinholes, abrasions, or other discontinuities exist, an additional coat shall be applied to the affected areas within 30 minutes.

Areas where the curing compound is damaged by anything such as construction operations or saw cutting within the curing period has to be immediately re-

sprayed. It is also critical for the sides of the pavement to have curing compound applied. Figures 4-115 and 4-116 show poor application.

Figure 4-113 Good Application of Curing Compound



Figure 4-114 Good Application With Overlapping Spray and Windscreens



Figure 4-115 Poor Application of Curing Compound Vertical Joint



Figure 4-116 Poor Application of Curing Compound Vertical Joint



4-15.2.2 Moist Curing. This method is not used often since it is difficult to do correctly for the 7 day period. It is a requirement that it be used for overseas

projects using Silica Fume in the mix. For these projects a minimum 24-hour moist cure is required before applying membrane curing compound. The burlap will have to be pulled back to cut contraction joints (Figure 4-117) and has to be immediately reapplied.

Figure 4-117 Moist Cure Method (Temporarily Removed For Saw Cutting)



The moist cure method consists of maintaining the surfaces continuously wet for the entire curing period, or until curing compound is applied. It commences immediately after finishing. Surfaces can also be cured by ponding; continuously sprinkling, continuously saturated burlap or cotton mats, or by continuously saturated plastic coated burlap. Burlap and mats have to be clean and free from any contamination and completely saturated before being placed on the concrete. The sheets are to be lapped to provide full coverage. This method has to provide a system to ensure that moist curing is continuous 24 hours per day and that the entire surface is wet.

4-15.3 Checklist for Curing.

- Curing compound meets CRD-C 300 (note: more restrictive than ASTM C 309).
- Curing equipment ready and in good working order.
- Cure applied immediately after finishing and bleed water disappears.
- Automatic, self-propelled spray machine used.
- Mechanical agitation of curing compound.
- Check proper rate in test section as well as during production.
- Check quantities used and surface applied to insure correct rate.
- Uniform coverage in addition to any vertical edges.
- Re-apply after saw cutting or damage of membrane.
- The application of curing compound is uniform.
- Spray nozzles are set to correct height and not clogged.
- Cure machine speed set correctly for proper coverage.
- Curing compound is sufficiently mixed.
- Hand spraying only for odd shaped areas and with two separate coats at 90 degrees.

4-15.4 Protection.

The pavement has to be protected against all damage prior to final acceptance of the work. Protection is required at all times and many times starts with rainfall protection. Waterproof cover should be at the site when there is a threat of inclement weather. There also has to be a method to rapidly place the cover without walking on it or damaging it. Concrete surfaces that are subjected to rainfall within 3 hours of the curing compound being applied have to have it reapplied. Pavement that is subjected to rainfall has to be cored and examined by a petrographer. Damaged concrete is to be removed and replaced. Damaged concrete is described as a surface that is weakened from excessive water or where aggregates are exposed. Both of these situations will eventually lead to FOD on the surface. Figure 4-118 shows slightly damage from rainfall and Figure 4-119 shows severe damage. In either case, cores should be taken and evaluated by a qualified Petrographer.

Aggregates, rubble, or other similar construction materials cannot be placed on airfield pavements (Figure 4-120). Traffic also has to be excluded from the new pavement by erecting and maintaining barricades and signs until the concrete is at least 14 days old. To maintain schedule and production efficiency, a contractor may request to pave the “fill-in” lane(s) between the newly placed pilot lane(s). Hauling equipment could be permitted on the new pavement after the pavement has been cured for 7 days if the joints have been sealed or otherwise protected.

Figure 4-118 Slight Rain Damage



Figure 4-119 Excessive Rain Damage



Other necessary equipment may be permitted to ride upon the edges of previously constructed slabs only if the concrete has attained a minimum field cured flexural strength of 550 psi and approved means (such as mats or plywood) are furnished to prevent damage. All new and existing pavements carrying construction traffic or equipment has to be continuously kept completely clean. Any spillage has to be cleaned up immediately and the contractor has to have a broom and use it daily when using the pavement for traffic. Figure 4-121 is an example of damage from construction equipment on new pavements.

Figure 4-120 Poor Protection With Aggregates and trafficking on Surface



Figure 4-121 Spall Damage



4-15.5 Protection Checklist.

- Protect pavement from all damage until final acceptance.
- Reapply curing if damaged within the cure period.
- Sufficient waterproof cover when threat of inclement weather.
- Means to rapidly place cover.
- Reapply cure compound if subject to rain.
- No aggregate or rubble stored on pavement.
- Keep surface clean and have broom available and use daily if traffic exists.
- Sufficient field cured sample strength to permit necessary construction equipment to use pavement.
- Clean up any spillage or debris immediately.
- Remove and replace damaged pavement.

4-15.6 Hot Weather Protection.

When the ambient temperature during paving is expected to exceed 90 degrees F, the procedures for concrete placement have to conform to hot weather concrete requirements. The concrete temperature at time of delivery to the forms cannot exceed 85 degrees F when the Relative humidity during placement is 40 to 60% and 80 degrees F when the relative humidity is less than 40%.

Cooling of the mixing water or aggregates or placing in the cooler part of the day may be required to obtain an adequate placing temperature. Steel forms and reinforcing should also be cooled below 120 Degrees F. Trucks and placing equipment may also have to be cooled to maintain concrete placing temperatures. The base course must be dampened prior to placement, but should not have any areas of ponded water.

Plastic shrinkage cracks develop during weather with low humidity, high temperatures, and wind. It is critical that if they do occur that they not be finished over with mortar or paste since they will eventually appear. During these conditions other protective measures will be necessary if the contractor proceeds. These measures include windbreaks, shades, wet covering, fogging the surface after the finish or spraying it with a monomolecular film after finishing. When such fogging treatment is stopped, curing procedures shall be immediately commenced. The monomolecular film is 90 percent water and it is important that it and the fogging mist not be finished into the surface. Plastic shrinkage cracks that occur shall be repaired in accordance with the contract.

Figure 4-122 from ACI 305 can be used to predict the condition when plastic shrinkage cracking may exist. Usually when the evaporation rate exceeds 0.2 lbs/sf/hr, the potential for plastic shrinkage cracks exist.

EXAMPLE: The concrete placement is being done when the air temperature is 65 degrees F. Relative humidity is 40%, concrete temperature is 60 degrees F and wind speed is 20 mph. By using Figure 4-122, an evaporation rate of 0.16 lbs/sf/hr is determined. The potential for the plastic shrinkage crack is unlikely in this situation, however if the concrete temperature was at 70 degrees F, the potential would exist.

Figure 4-122 --- ACI 305

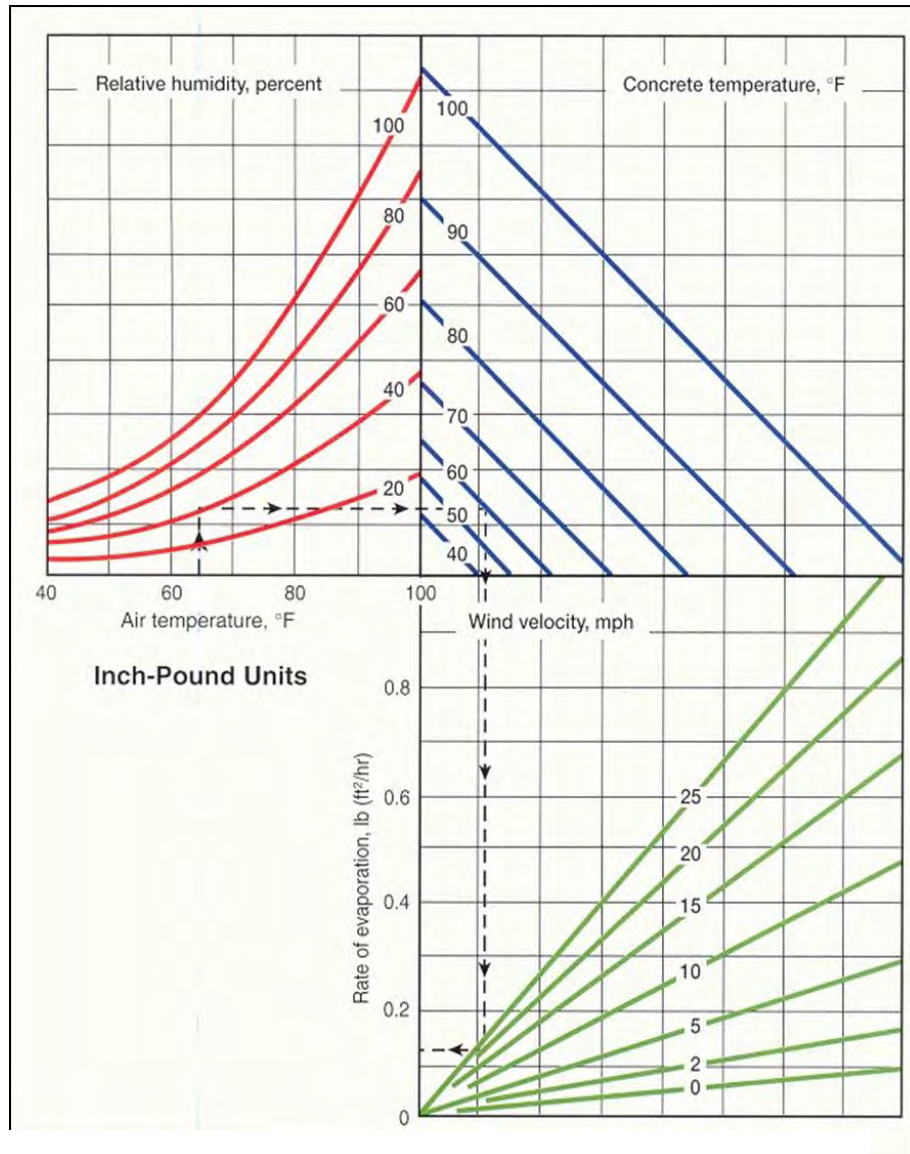

4-15.7 Checklist for Hot Weather Concrete.

- Ambient temperature during paving is expected to exceed **90 degrees F**.
- PCC cannot exceed 85 degrees F when the relative humidity during placement is 40 to 60% and 80 degrees F when the relative humidity is less than 40%.
- Cool the mixing water or aggregates or place during cooler ambient temperatures.
- Steel forms and reinforcing cooled below 120 Degrees F.
- Trucks and equipment may also have to be cooled to lower concrete temperature.
- Dampen base course.
- Plastic shrinkage cracks, during low humidity, high temperatures, and wind.
- Do not finish over plastic shrinkage cracks.
- Use windbreaks, shades, wet covering, fogging or monomolecular film.
- Curing procedures shall be immediately commenced.
- Repair plastic shrinkage cracks in accordance with the contract.
- Use ACI 305 to predict the condition when plastic shrinkage, evaporation rate exceeds 0.2 lbs/sf/hr

4-15.8 Cold Weather Protection.

When concrete freezes at an early age it will become damaged. The concrete has to have sufficient temperature for the cement to hydrate and gain strength. The strength at the early ages is especially important in arid and semi-arid locations. When concrete is placed late in the season and in cold weather one has to be careful to ensure that cold weather damage does not occur. The strength gain will cease when ambient temperature drops to 40 degrees F. At the time the temperature starts to rise, insufficient water will be available for the cement hydration.

Special protection is required in cold temperatures and when anticipated drops in ambient temperatures occur within the cure period. Placement of concrete cannot begin unless the ambient temperature is at least **35 degrees F** and rising. Placement of concrete is to be halted whenever the ambient temperature drops to **40 degrees F** and **chemicals and other admixtures shall not be used**. When the ambient temperature is less than **50 degrees F**, the temperature of the concrete when placed has to be between **50 and 75 degrees F**. This may have to be accomplished by heating the mixing water or aggregates. Materials entering the mixer cannot have ice, snow, or frozen lumps. If permitted in the contract, an accelerating admixture may be used when the ambient temperature is below **50 degrees F**. Any concrete damaged by freezing shall be removed full depth.

Covering and other means of protection shall be provided for maintaining the concrete at a temperature of at least **50 degrees F** for not less than 72 hours

after placing, and at a temperature above freezing for the remainder of the curing period. ACI 306 is an excellent source of information for cold weathering concrete. External heating with combustion type heaters can be detrimental to the concrete from the exhaust gases.

EXAMPLE: It is proposed to pave an 18-inch thick pavement and the ambient temperatures are expected to drop to a low of 22 degrees F within the 7 days after placement. The mix being used contains 400 pounds of cement and 80 pounds of flyash. In order to maintain the pavement above 50 degrees F for the first 72 hours (3 days) and above 35 degrees F for the remaining 7 day cure, insulation will be utilized. Table 4-2 from ACI 306 is used to determine the R value required for insulation. The flyash is not considered since it does not contribute to the heat of hydration. For a mix having under 400 pounds of cement and 18-inches thick, an R value of 4.0 is required. Note that some conditions will not be adequate with insulation and will require heat from an external source.

Table 4-2 Minimum Exposure Temperatures for Concrete Flatwork placed on the Ground for Concrete placed and Surface Temperature Maintained at 50 F (10 C) for 3 days on ground at 35 F (2 C)---ACI 306

| Slab thickness, in. (m) | Minimum ambient air temperature, deg F (C) allowable when insulation having these values of thermal resistance R, hr•ft ² •F/Bru (m ² •K/W), is used | | | |
|------------------------------------------------------------------|----------------------------------------------------------------------------------------------------------------------------------------------------------------------------|--------------|--------------|--------------|
| | R = 2 (0.35) | R = 4 (0.70) | R = 6 (1.06) | R = 8 (1.41) |
| Cement content = 300 lb/yd ³ (178 kg/m ³) | | | | |
| 4 (0.10) | * | * | * | * |
| 8 (0.20) | * | * | * | * |
| 12 (0.31) | * | * | * | * |
| 18 (0.46) | 42 (6) | 38 (3) | 32 (0) | 26 (-3) |
| 24 (0.61) | 37 (3) | 25 (-4) | 11 (-12) | -3 (-19) |
| 30 (0.76) | 31 (-1) | 15 (-9) | -1 (-18) | -17 (-27) |
| 36 (0.91) | 31 (-1) | 12 (-11) | -5 (-21) | -22 (-30) |
| Cement content = 400 lb/yd ³ (237 kg/m ³) | | | | |
| 4 (0.10) | * | * | * | * |
| 8 (0.20) | * | * | * | * |
| 12 (0.31) | 46 (8) | 44 (7) | 42 (6) | 40 (4) |
| 18 (0.46) | 36 (2) | 22 (-6) | 8 (-13) | -6 (-21) |
| 24 (0.61) | 28 (-2) | 9 (-13) | -10 (-23) | -29 (-34) |
| 30 (0.76) | 21 (-6) | 0 (-18) | -21 (-29) | -42 (-41) |
| 36 (0.91) | 21 (-6) | -4 (-20) | -29 (-34) | -50 (-46) |
| Cement content = 500 lb/yd ³ (296 kg/m ³) | | | | |
| 4 (0.10) | * | * | * | * |
| 8 (0.20) | * | * | * | * |
| 12 (0.31) | 42 (6) | 36 (2) | 30 (-1) | 24 (-4) |
| 18 (0.46) | 30 (-1) | 12 (-11) | -6 (-21) | -22 (-30) |
| 23 (0.61) | 11 (-6) | -5 (-21) | -31 (-35) | -50 (-46) |
| 30 (0.76) | 16 (-9) | -10 (-23) | -42 (-41) | -74 (-59) |
| 36 (0.91) | 16 (-9) | -18 (-28) | -50 (-46) | |
| Cement content = 600 lb/yd ³ (356 kg/m ³) | | | | |
| 4 (0.10) | ** | * | * | * |
| 8 (0.20) | ** | * | * | * |
| 12 (0.31) | 38 (3) | 26 (-3) | 14 (-10) | 2 (-17) |
| 18 (0.46) | 24 (-1) | 0 (-18) | -24 (-31) | -48 (-44) |
| 24 (0.61) | 14 (-10) | -16 (-27) | -46 (-33) | -82 (-63) |
| 30 (0.76) | 10 (-12) | -20 (-29) | -62 (-52) | † |
| 36 (0.91) | 7 (-14) | -30 (-34) | † | † |

* > 50 F (10 C): additional heat required
† < -60 F (-51 C)

4-15.9 Checklist for Cold Weather Placement.

- Placement of concrete shall not begin unless the ambient temperature is at least 35 degrees F and rising.
- Placement of concrete shall be halted whenever the ambient temperature drops to 40 degrees F.
- When the ambient temperature is less than 50 degrees F, the temperature of the concrete when placed shall be not less 50 degrees F nor more than 75 degrees F.
- Heating of the mixing water or aggregates will be required to regulate the concrete placing temperature.
- Materials entering the mixer shall be free from ice, snow, or frozen lumps.
- Salt, chemicals or other materials shall not be incorporated in the concrete to prevent freezing.
- If permitted by contract, an accelerating admixture may be used when the ambient temperature is below 50 degrees F.
- Covering and other means shall be provided for maintaining the concrete at a temperature of at least 50 degrees F for not less than 72 hours after placing.
- Must stay above freezing for the remainder of the curing period.
- Pavement slabs damaged by freezing shall be removed
- Cold weather paving shall conform to ACI 306R.
- Temperatures (ambient and concrete surfaces) continually monitored and recorded.

4-16 GRADE AND SMOOTHNESS.

4-16.1 Introduction.

Grade is the surface elevation of the pavement. Grades are established by the designer to meet longitudinal and transverse requirements for the feature (UFC 3-260-01); to provide runoff control; and to prevent ponding of rainwater or snow melt on the pavements. Grade is controlled in the field by the Contractor, using string lines or fixed forms to establish the surface elevation of the pavement.

The term “smoothness” is a misnomer. What is actually measured is “roughness,” which is the variance in vertical elevation of a pavement surface. Smoothness is the absence of roughness and is strongly correlated with overall pavement quality, aircraft vibrations and stresses; and “rideability.”

The terms “grade” and “smoothness” are not the same. A pavement constructed to grade may not be smooth and, conversely, a smooth pavement may not be at grade. Separate measurements are required for each property. Both properties of the finished pavement are pay items, per the UFGS.

4-16.2 Grade.

Grade testing is performed on a lot basis, corresponding to one shift of production not to exceed 1000 cubic yards. The grades shall be evaluated within 5 days of the lot's placement, so that grinding or other corrections can be made before adjacent lanes are placed. The finished surface of the pavement area shall be tested by the Contractor, by running lines of levels at intervals corresponding with every longitudinal and transverse joint to determine the elevation at each joint intersection. The results of this survey shall be recorded and a copy given to the Government at the completion of the survey of each lot.

All survey work shall be performed under the supervision of a Licensed Surveyor. Pavement elevations shall be measured to the nearest 0.01 foot and all level circuits should be closed to a known benchmark.

The analysis shall be performed by the government, since grade is a pay item. Compare the surveyed grades at each joint intersection with the grades shown on the contract drawings. The pay reduction factor is discussed in section 4-19.

The finished surfaces of airfield runway, taxiway, and apron pavements shall vary not more than 1/2 inch (0.04 foot) above or below the plan grade line or elevation indicated. This tolerance from the approved grade line and elevation will not be permitted in areas where closer conformance with the planned grade and elevation is required for the proper functioning of appurtenant structures. The finished surfaces of new abutting pavements shall coincide at their juncture.

4-16.3 Smoothness.

Smoothness testing is performed on a lot basis, corresponding to one shift of production not to exceed 1000 cubic yards. After the concrete has hardened sufficiently to permit walking thereon, but not later than 48 hours after placement, the smoothness shall be evaluated, so that grinding or other corrections can be made before adjacent lanes are placed.

The specifications permit two types of smoothness measuring equipment: a 12-foot long straightedge or a California profilograph. The profilograph method shall be used for all longitudinal testing, except for paving lanes less than 200 feet in length. The straightedge method shall be used for transverse testing, for longitudinal testing where the length of each pavement lane is less than 200 feet, and at the ends of the paving limits for the project. Where drawings show required deviations from a plane surface (crowns, drainage inlets, etc.), the surface shall be finished to meet the approval of the Contracting Officer.

The entire area of the pavement shall be tested in both a longitudinal and a transverse direction on parallel lines. The transverse lines shall be 15 feet or less apart, as directed. The longitudinal lines shall be at the centerline of each paving lane shown on the drawings, regardless of whether the Contractor is

allowed to pave two lanes at a time, and at the 1/8th point in from each side of the lane. Other areas having obvious deviations shall also be tested. Longitudinal testing lines shall be continuous across all joints. Transverse testing lines for pilot lanes shall be carried to construction joint lines and for fill-in lanes shall be carried 24 inches across construction joints, and the readings in this area applied to the fill-in lane. Straightedge testing of the longitudinal edges of slipformed pilot lanes shall also be performed before paving fill-in lanes.

4-16.3.1 Straightedge. The straightedge shall be held in contact with the surface and moved ahead one-half the length of the straightedge for each successive measurement. The amount of surface irregularity shall be determined by placing the freestanding (unleveled) straightedge on the pavement surface and measuring the maximum gap between the straightedge and the pavement surface. Measurements shall be determined along the entire length of the straight edge.

Verify the straightedge is straight before starting measurements. Snap a string line along the length of the straightedge to check for deviations.

The analysis shall be performed by the government, since smoothness is a pay item. Calculate the percentage of measurements exceeding the limits of Table 4-3. The pay reduction factor is discussed in Section 4-19.

Table 4-3 Straightedge Smoothness Limits

| Airfield Feature | Longitudinal Limit | Transverse Limit |
|--------------------|------------------------------------|------------------|
| All Pavements | No abrupt change of ¼ inch or more | |
| Runways | 1/8 inch maximum | ¼ inch maximum |
| Taxiways | 1/8 inch maximum | ¼ inch maximum |
| All Other Features | ¼ inch maximum | ¼ inch maximum |

4-16.3.2 Profilograph. Profilograph testing shall be performed using approved equipment and procedures described in State of California, Department of Transportation, Standard 526 (CDT Test 526).

A typical California profilograph is shown in Figure 4-123. The wheelbase is 25 feet long and the truss frame is supported on 6 support wheels at each end. The profile is recorded from the vertical movement of a wheel attached to the frame at mid-point and is in reference to the mean elevation of the points of contact with the road surface established by the support wheels. The profilograph shall utilize electronic recording and automatic computerized reduction of data to indicate "must-grind" bumps and the Profile Index (PI) for each 0.1 mile segment of the pavement lot.

Figure 4-123 California Profilograph (Note Measuring Wheel in Center of Frame is Retracted for Transporting)



Calibration of the horizontal and vertical measuring systems should be performed before every use. Calibrate and inspect the following items:

- Tire pressure on measuring wheel. Low pressure in the measuring wheel tire makes the recording system insensitive to surface roughness.
- Vertical deflection under measuring wheel. Use several spacers of known thickness under the tire to check the recording device's response.
- Horizontal distance measurement. Layout a known length on the pavement and traverse with the profilograph to check the recording device's response.
- The pavement surface shall be clean and free from laitance to avoid biasing the deflection measurements. Burlap drag or broom finishes will not affect the recorded vertical deflections.
- Operator qualifications. Certification by equipment manufacturer or a state Department of Transportation.

An inertia profiler has been developed for highway use (Figure 4-124), in accordance with ASTM E 950. These devices use accelerometers to profile the surface of the pavement as the profiler is driven down the pavement. The data obtained is a continuous record of pavement surface elevation and distance traveled and may be converted to a California profilograph Profile Index using the manufacturer's software or the Federal Highways PROVAL program (FHWA, 2006). Since the UFGS specifies measuring the smoothness on a lot basis, typically about 1000 feet for airfield pavement thicknesses, there is no real advantage to using this more expensive piece of equipment. On highway work, the smoothness is measured at the end of the job, so the inertia profiler can obtain all the data in a day or two.

Figure 4-124 Inertial Profiler (“LISA,” Manufactured by Ames Engineering)



A copy of the reduced tapes shall be furnished the Government at the end of each day's testing. The analysis shall be performed by the government, since smoothness is a pay item. The pay reduction factor is discussed in Section 4-19.

A segment of a profilograph trace is shown on Figure 4-125 and the specification requirements are provided in Table 4-4. Check the profilograph traces and data package for the following items:

- The "blanking band" shall be 0.2 inches wide and the "bump template" shall span 1 inch, with an offset of 0.4 inch.
- The profile index shall be computed for each pass of the profilograph (3 per lane) in each 0.1 mile segment.
- The profile index for each segment shall be the average of the profile indices for each pass in each segment.
- Profilographs of unequal lengths shall be scaled and proportioned to an equivalent 0.1 mile, as outlined in CDT Test 526.
- Grade breaks on aprons shall be accommodated by breaking the profile segment into short sections and repositioning the blanking band on each section.
- The profilograph testing of the last 30 feet of a paving lane in the longitudinal direction from each day's paving operation shall be counted on the following day's continuation lane.

Figure 4-125 Segment of Profilograph Trace (Units Are Metric (Horizontal Distance in Meters, and Vertical Deflection in Millimeters). Blanking Band Is Shown in Yellow)

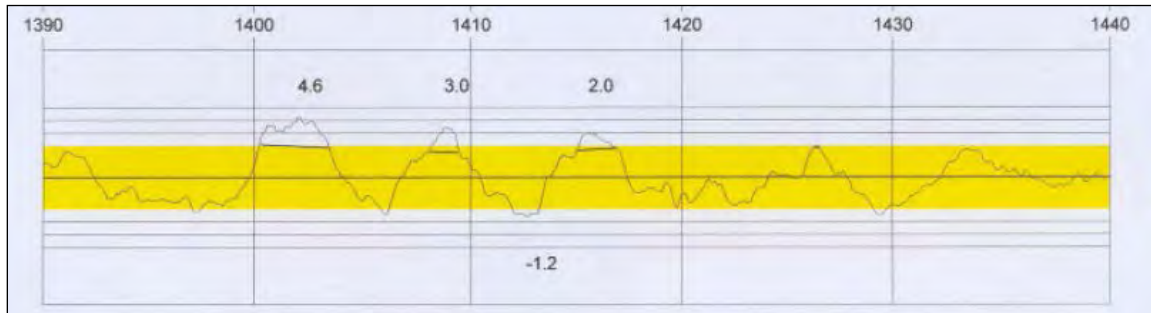

Table 4-4 Profilograph Smoothness Limits Per 0.1 Mile Segment

| Airfield Feature | Longitudinal Limit | Transverse Limit |
|--------------------|------------------------------------|------------------|
| All Pavements | No abrupt change of ¼ inch or more | |
| Runways | 7 inches/mile maximum | Use Straightedge |
| Taxiways | 7 inches/mile maximum | Use Straightedge |
| All Other Features | 9 inches/mile maximum | Use Straightedge |

Any bumps ("must grind" areas) shown on the profilograph trace which exceed 0.4 inch in height shall be reduced by diamond grinding until they do not exceed 0.3 inch when retested.

4-16.4 Diamond Grinding.

In areas not meeting the specified limits for surface smoothness and plan grade, high areas shall be reduced to attain the required smoothness and grade, except when depth is limited below. High areas shall be reduced by grinding the hardened concrete with an approved diamond grinding machine after the concrete is at least 14 days old.

4-16.4.1 Equipment.

- Grinding shall be accomplished by sawing with an industrial diamond abrasive which is impregnated in the saw blades.
- The saw blades shall be assembled in a cutting head mounted on a machine designed specifically for diamond grinding that will produce the required texture and smoothness level without damage to the concrete pavement or joint faces.
- The saw blades shall be 1/8-inch wide and there shall be a minimum of 55 to 60 blades per 12 inches of cutting head width depending on the hardness of the aggregate.
- Each machine shall be capable of cutting a path 3 to 4 feet wide.

- Grinding equipment that causes ravels, aggregate fractures, spalls or disturbance to the joints will not be permitted.

A typical diamond grinding plant is shown on Figure 4-126.

Figure 4-126 Diamond Grinding



4-16.4.2 Execution.

- The area corrected by grinding the surface of the hardened concrete shall not exceed 10 percent of the total area of any subplot.
- The depth of diamond grinding shall not exceed 1/4 inch. All pavement areas requiring plan grade or surface smoothness corrections in excess of the limits specified above, shall be removed and replaced.
- Grinding shall be tapered in all directions to provide smooth transitions to areas not requiring grinding.
- In pavement areas given a wire comb or tined texture, areas exceeding 25 square feet that have been corrected by diamond grinding shall be retextured by transverse grooving using an approved grooving machine of standard manufacture. All areas in which diamond grinding has been performed will be subject to the thickness tolerances specified in Section 4-19.
- All ground areas shall be remeasured for grade and smoothness.

4-16.5 Compliance Checklist.

- Grade:
 - Results reported within 5 days of placement.
 - Level circuit closed.
 - Measurements to nearest 0.01 foot.
 - Results analyzed for acceptance.
- Smoothness:
 - Testing conducted within 48 hours of placement.
 - 3 lines in longitudinal direction.
 - Straightedge:
 - 12 feet long and straight.
 - Transverse spacing maximum of 15 feet.
 - Results analyzed for acceptance.
- Profilograph:
 - Equipment calibrated.
 - Traces and data package provided.
 - Blanking band and bump template meet specifications.
 - Results analyzed for acceptance.
- Diamond Grinding:
 - Equipment meets specification requirements.
 - Ground areas are cored for thickness measurement and remeasured for grade and smoothness.

4-17 CONSTRUCTION AND CONTRACTION JOINTS.

4-17.1 Introduction.

There are two basic joint types: construction and contraction. A construction joint is a transverse or longitudinal joint where two adjacent but separate placements of concrete meet. Contraction joints are installed within the placement to control the cracking of the pavement at designated locations. The cracks are induced from an initial sawcut. It is critical to have the joints placed correctly to avoid mid-panel cracking as shown in Figure 4-127.

Load transfer is necessary across construction and contraction joints for airfields since the thickness is designed based on providing the adjacent panel carrying part of the load (25%). Contraction joints normally provide sufficient load transfer through the aggregate interlock from the irregular face of the crack if the joint does not open excessively.

Figure 4-127 Mid-panel Cracking



4-17.2 Construction Joints.

Construction joints (unless it is thickened edge) will normally have dowels installed to provide a load transfer since aggregate interlock doesn't exist between the placements. Keys have also been used and are not permitted for most agencies. They have not performed as well as dowels.

4-17.2.1 Keyed Joint. Keyed are not used and not recommended however the following guidance is being provided. If keyways are required the female side is formed with a thin gage metal liner. It is extruded during the slipform placement and has to be within 1/4 inch (6 mm) from the center depth of the slab. The dimensions of the keyways should be checked and within 1/8-inch (3mm). The liner for the female joint is required to be left in place in the joint for support. The construction of a male keyway should never be considered since it is difficult to adequately consolidate and support since it is cantilevered over the joint face.

4-17.2.2 Thickened Edge. If the load transfer cannot be maintained at the joint (expansion or slip joints), the panel edge should be thickened by 25% on both sides to account for the additional tensile stress in the upper half of the slab. The thickened edge should be tapered back to the normal thickness to the next joint, but not less than 10 feet. These are not installed without being designed and planned well in advance, since it affects grading of the subgrade, and subbase, and subsurface drainage.

4-17.2.3 Expansion and Slip Joint. The thickened edge construction joint is normally used with expansion joint material or slip-joint material to isolate a joint pattern or structure. Expansion joints are normally kept to a minimum since they require extensive maintenance. Thickened edges are also used at the edge of

pavements where extensions are planned for the future. Dowels should never be installed in expansion or isolation joints where they do not match the adjacent joint pattern. The joint movement will cause reflective cracking across the doweled joint. Similar cracking can occur when new panels are doweled to existing cracked panels when the cracking does not match the new joint pattern. The expansion or slip joints should be parallel to long stretches of pavement, such as a runway, that moves longitudinally with temperature changes. Omitting the joint or not continuing it in a straight line along the connecting pavement will result in shoving and buckling.

Expansion and slip joints are used to provide a complete, uniform separation between the structure and the pavement. The filler is attached to the original concrete placement with adhesive or fasteners and it is critical that it extend the full slab depth. Sections of filler have to be fitted tightly together in order to prevent entrance of concrete into the expansion space. Edges of the concrete at the joint face have to be finished with an edger with a radius of **1/8 inch (3 mm)**. A filler strip can be installed on top of the preformed expansion material. This filler material has to be installed **3/4 inch (19 mm)** below the pavement surface with a slight taper that can be removed to form the sealant reservoir.

4-17.2.4 Transverse Construction Joints. Transverse construction joints may also be used at the end of each day's placing operations. The location must match a planned contraction joint and not be placed randomly. Transverse construction joints are constructed by utilizing headers or by paving through the joint, then full-depth saw cutting the excess concrete as shown in Figure 4-128. The paving through and saw cutting provides the best quality. When using headers care has to be taken to insure proper consolidation and the excessive mortar should be run off past the header. These construction joints have to be doweled so either the header form will have to provide for the dowels or they are drilled and grouted after the concrete has gained sufficient strength.

4-17.3 Joint Plans.

The plans contain locations for the joints and should never be adjusted without coordination with the designer. Sawcuts must be made at designated places to insure that the PCC cracks at the desired location during curing. If sawcuts are not made timely, the PCC will crack randomly. The joint pattern for concrete overlays is even more critical. The joints in the overlay pavement must lineup with the underling joints to avoid reflective cracking.

Figure 4-128 Paving Through and Sawing Off End



4-17.4 Joint Alignment.

All joints have to be straight and continuous from edge to edge or end to end of the pavement. They should never have an abrupt offset and no gradual deviation greater than $1/2$ inch (13 mm). Edges have to be vertical within the tolerances from the top to bottom. Figures 4-129, 4-130, and 4-131 show joint faces (vertical edges) that are out of alignment. In some cases the slipform will be adjusted to flare the outer edge up in order to compensate for edge slump. This has to be finished straight with the pavement surface. When this top edge is flattened, the top portion of the vertical face will angle out and leave a cantilevered edge that is difficult to fit a sealant reservoir.

4-17.5 Partial Panels

Partial panels should never be constructed. These construction joints will eventually move and result in cracking in the adjacent panels as shown in Figure 4-132. It is critical to maintain the designed joint pattern.

Figure 4-129 Poor Quality Construction Joint



Figure 4-130 Poor Quality Thickened-Edge Joint Construction



Figure 4-131 Out of Tolerance Joint Construction –Vertical Edge



Figure 4-132 Cracks Induced by Partial Panel Replacement



4-17.6 Drainage Structures and Embedments

Designs typically call for drainage structures and embedded light cans (Figure 4-133). The designs do not always coordinate the location of the cans and

structures with the joint layouts but these can affect the paving operation and if not positioned correctly can cause random cracking.

Figure 4-133 Light Cans Properly Located With the Joints



The light cans should be located 2-feet from a joint on the paving plan well in advance of installing the foundations for them. Typically the cans can be moved slightly within a tolerance and avoid conflicts with constructions and contraction joints. It is important not to avoid a block out in the panel and across a joint to accommodate the can (Figure 4-134). These block outs have to be doweled to provide load transfer, but will eventually crack.

Drainage structures should be positioned to not interfere with the joint layout. The structures should be planned and positioned in order that movement will not induce cracking in the panels (See Figure 4-135).

NOTE: Imperative to hold discussions with contractors to discuss embedded items (observation risers, light cans/bars, hand holes, etc.) to avoid impacting joints. Light barrettes having an uneven number (3 cans - termination lights and 5 cans - approach lights) can create location conflicts between the light cans and joints. Airfield lighting design criteria allows for tolerances from planned locations to avoid such situations, contact the designer early on to resolve such issues.

Figure 4-134 Light Cans Interfering With Joint Lines



Figure 4-135 Drainage Structure – Joint Lines not matched and Random Cracking



4-17.7 Joint Check List.

- Placement plan approved with joint types and locations.
- Light cans and drainage structures planned to avoid conflicts with joints and positioned so they do not induce cracking.
- Expansion and slip joints continuous along joints and top to bottom.
- Thickened edges are graded in base and subgrade.
- Existing pavements with working cracks are isolated from new pavement.
- Check keyway dimensions for location and dimensions.
- Check abrupt offsets of construction joints and horizontal deviation.
- Check vertical face of construction joint to be with the tolerances.
- Transverse construction joints at stopping points be doweled and at planned joint location.
- Edges of joints area rounded with a 1/8 –inch radius.
- Hold meeting with contractors to discuss the location of light cans and embedment and conflicts with planned joint locations.

4-18 JOINT SAWING AND SEALING.

4-18.1 Introduction.

Portland cement concrete will start to shrink as it sets and will eventually crack from the reaction of the cement hydration, water loss, and a decrease in temperature. Contraction joints are installed to control the crack locations. They are normally accomplished by saw cutting, and the timing for cutting is critical so cracks do not occur at random locations. The saw cuts are later widened to permit the installation of the sealant.

4-18.2 Saw Cut - Joint Layout.

Surveying should be used to establish transfer joint locations across paving lanes. The joints have to lineup across all of the pilot lanes and fill-in lanes (Figure 4-136).

The joints should always be sawn at the required depth and spacing and consecutively in the sequence of the concrete placement. Older placements will tend to move and crack sooner.

Figure 4-136 Lined Up Transverse Joints Across Pilot Lanes



4-18.3 Timing for Sawing.

Timing of the cutting is critical since too early will cause spalling, chipping, and tearing of the concrete (Figures 4-137 and 4-138). Saw-cutting too late will result in random cracking. Minor defects along the sawcut may be acceptable provided that they are small enough to be removed with the widening for the sealant reservoir. If the larger sand sizes or coarse aggregates are being dislodged, it is too excessive.

The sawcut almost always has to be made within several hours of the time of placement, depending on the temperature, set time and strength gain of the concrete. Saw cutting personnel and equipment have to be standing by in order to start at the right time. The approximate moment to start the cutting is when a nail will start to scratch the surface without gouging, however it varies with different mixes. Other methods for the timing determination may be used such as maturity method, but primarily experience of the saw cutters. The sawing operation will vary throughout the day and is likely to be accomplished at night.

Figure 4-137 Spalling from Premature Saw Cutting

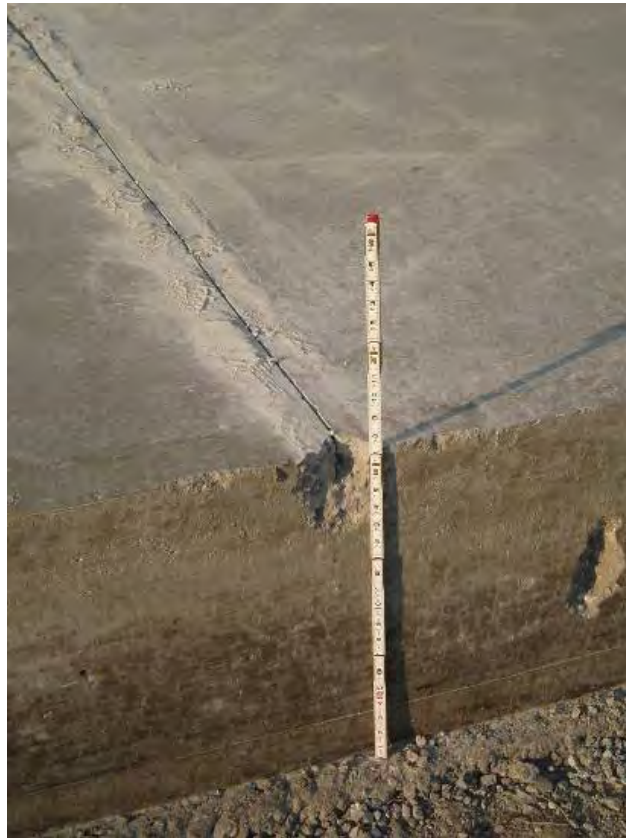

Figure 4-138 Spalling from Premature Saw Cutting



In some cases cracking can occur prior to or during initial saw cutting. Timing of saw cutting fill-in lanes is more critical since daily temperature movement of the pilot and the restraint from the construction joint dowels will induce cracks earlier than the pilot lanes.

Early entry saws (Figure 4-139) can be used to avoid the spalling, however the full depth saw cut has to be made within 24 hours in order for the crack to occur below the sealant reservoir. It is important for all sawcut joints to move and crack. This will insure movement of the concrete to occur over all the joints and not just a few.

Figure 4-139 Early Entry Saw



In most cases when the concrete is placed during the daylight, the saw cutting will occur at night. In order to follow the alignment and monitor the operation, adequate lighting has to be provided. Illumination using vehicle headlights is not adequate.

A chalk line is normally used as a guide for alignment of the sawcut joint. Before and during the sawing, the concrete has to be examined closely and monitored for cracks. The joint should not be sawed if a crack has occurred near the planned joint location. Sawing is also discontinued when a crack develops ahead of the saw cut. Immediately after the joint is sawed, the saw cut and adjacent concrete surface has to be thoroughly flushed with water. Figure 4-140 shows a cut that was not flushed. It is required to collect the cuttings and properly dispose of them for environmental reasons.

Figure 4-140 Cuttings Not Removed



4-18.4 Depth of Sawcut.

Movement should occur in all the joints and will be indicated by cracking in all of the pilot lane joints over a couple weeks. The normal depth is the thickness divided by 4, but can vary with the design. If half of the joints are moving, the amount of movement will double in the cracked joints. This movement can become excessive and the sealant can be overstressed, resulting in cohesion or adhesion failure. If there are more un-cracked joints than desired, the Transportation System Center should be advised and the contractor may have to be directed to saw succeeding joints 25 percent deeper than originally indicated. The contract should provide for this at no additional cost to the Government.

4-18.5 Sawing Equipment.

The saw cutting equipment should be diamond-tipped bladed saws (Figure 4-141) mounted on wheels. It should be equipped with an alignment system. An adequate number of saws should be on site and spares should also be available (Figure 4-142). The blades should be in good condition in order to obtain a clean cut with no spalling.

4-18.6 Temporary Sealing and Curing.

Necessary precautions shall be taken to insure that the concrete is properly protected from damage and cured at sawed joints. The top of the joint opening and the joint groove at exposed edges shall be tightly sealed with cord backer rod before the joint is re-sprayed with curing compound (Figure 4-143). The surface shall be re-sprayed with curing compound as soon as free water disappears. This is a critical part of the surface and the cure has to be maintained until sawing the joint sealant reservoir has been completed. The backer rod prevents incompressibles from entering the crack.

Figure 4-141 Diamond Saw Blades



Figure 4-142 Saw Cutting Machine With Multiple Blades



Figure 4-143 Saw Cut With Temporary Foam Rope

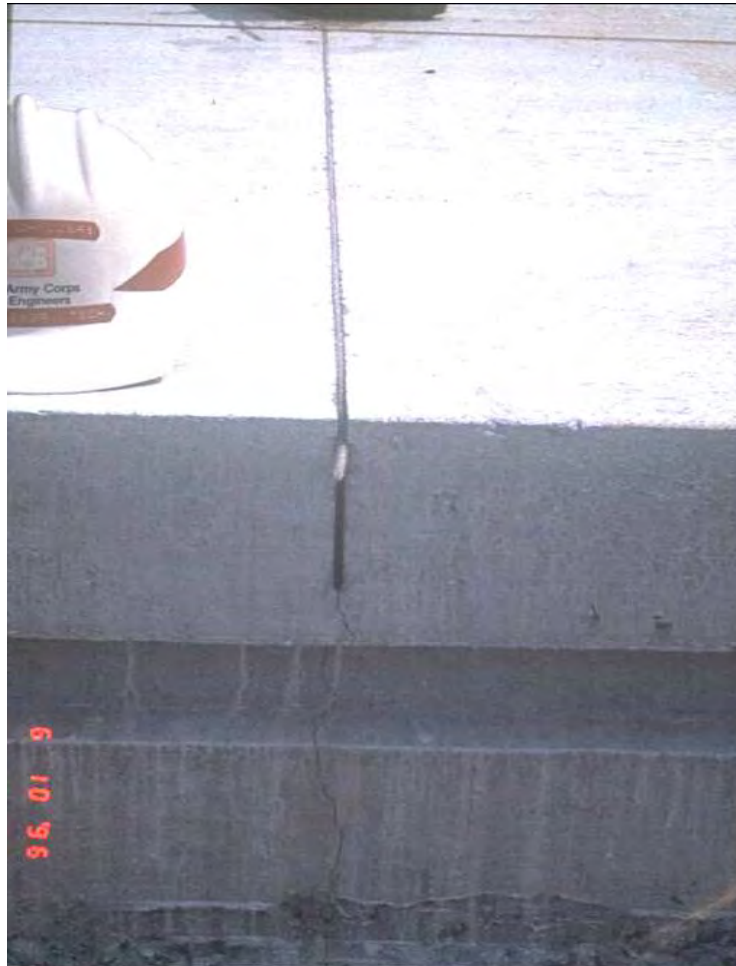

4-18.7 Random Cracking.

The specifications contain requirements for repair or removal and replacement. Figure 4-144 shows a random crack from late saw cutting. The cracks should be cored as soon as possible to determine if they are full depth (Figure 4-145). Normally if the crack migrates across most of the panel, transversely across the panel parallel to contraction joints, it will be found to be full depth. Leaving the slab in place will eventually result in the crack extending across other slabs.

Figure 4-144 Random Cracking from Late Saw Cutting



Figure 4-145 Core to Verify Depth of Crack



4-18.8 Factors Affecting Timing of Sawing.

- Bonding between base and concrete.
- Panel sizes.
- Condition of saw blades and rotation direction.
- Types of bases; porous, stabilized, granular.
- High wind, low humidity.
- Mix properties and admixtures.
- Cementitious material quantities.
- Concrete cure temperature.
- Admixtures and possible retarded set.
- Paving fill in lanes and movement in pilot lanes.
- Sudden temperature drop or increase.

4-18.9 Check List for Sawing.

- Visually check for joints lining up across all pilot lanes.
- Initial sawcut using 1/8 inch diamond blade at the required depth based on pavement thickness.
- Sawcut as soon as possible without spalling, chipping or tearing surface.
- Flush initial sawcut with water to remove cuttings and incompressible debris.
- Seal initial sawcut with backer rod and reapply cure.
- Early entry saws are acceptable for initial cut but have to be re-cut to specified depth within 24 hours.
- Sealant reservoir is to be cut after cure period.
- Joint locations should be marked on the base, edge of the slab, or on the forms.
- Sawcut depths need to be checked for each saw utilized on the test strip.
- Transverse sawcuts need to be carried through longitudinal free edges or as close to forms as possible.
- Pilot lane has to be checked for cracking at saw cut locations and depth of cut may have to be increased.

4-18.10 Joint Reservoir Sawing.

After the cure period is over the joints are widened to the required dimensions for the joint seal. It is important that construction joints be finished with an edging tool to form a smooth rounded surface of 1/8 inch (3 mm) radius. This is important so it can be followed during reservoir sawing directly over the joint. Figure 4-146 is an example where the joint did not have a radius trowel used. The reservoir has to be centered over the initial joint face. A reservoir for the joint sealant shall be sawed to the dimensions specified for the particular type of joint by using gang mounted diamond saw blades (stacked dado blades). The reservoir has to be thoroughly cleaned so adequate bonding is obtained. It is

critical to have the joint reservoir width consistent and not varying as shown on Figure 4-147.

Figure 4-146 Poor Edge Troweled Construction Joint - Hard to Follow With Saw



Figure 4-147 Non-Uniform Joint Cut Width



Chamfering the joint is commonly done in snowplow areas to minimize spalling. This is normally done on a separate pass of the joint seal widening but could also be done at the same time. Figure 4-148 shows a blade normally used to chamfer. The plan will have the detail and it is usually ¼ inch chamfer. The top of the seal should always be installed below the bottom of the chamfer and on the vertical face of the reservoir (Figure 4-149). For runways, high speed taxiways and other pavements that will be grooved, the reservoir and seal should be deep enough to insure that the seal is installed below the bottom of the groove plus the depth tolerance.

Figure 4-148 Blades used to Chamfer Joint Reservoirs



4-18.11 Preparation for Sealant

The joint reservoir sides should be sandblasted prior to installation of sealant (4-150). The installation should be accomplished immediately after cleaning. Prior to placing liquid joint sealants, the joint should be cleaned and blown dry with filtered air. A backer rod is installed to provide the required depth and to prevent sealant from bonding to the reservoir bottom or entering the crack. Sealant has to be stored per the manufacturer's recommendations (Figure 4-151). The appropriate machine should be used to install the seal (Figure 4-152) to insure alignment and to not exceed the required elongation.

Figure 4-149 Chamfered and Sealed Joint



Figure 4-150 Sandblasting Joint



The joint installation plan should be reviewed prior to the start. It is important to select the proper starting point, regardless of field molded or compression type seals. Since most airfields, in profile, drain a certain direction, it is imperative that the contractor understand the joints will continue to carry water days after a rain event. If they start on the higher elevations and work their way toward lower

elevations, this may alleviate some delays in waiting for the joints to dry out completely.

Figure 4-151 Poor Storage of Joint Seals



Figure 4-152 Installation Of Preformed Joint Seal – Minimal Stretch

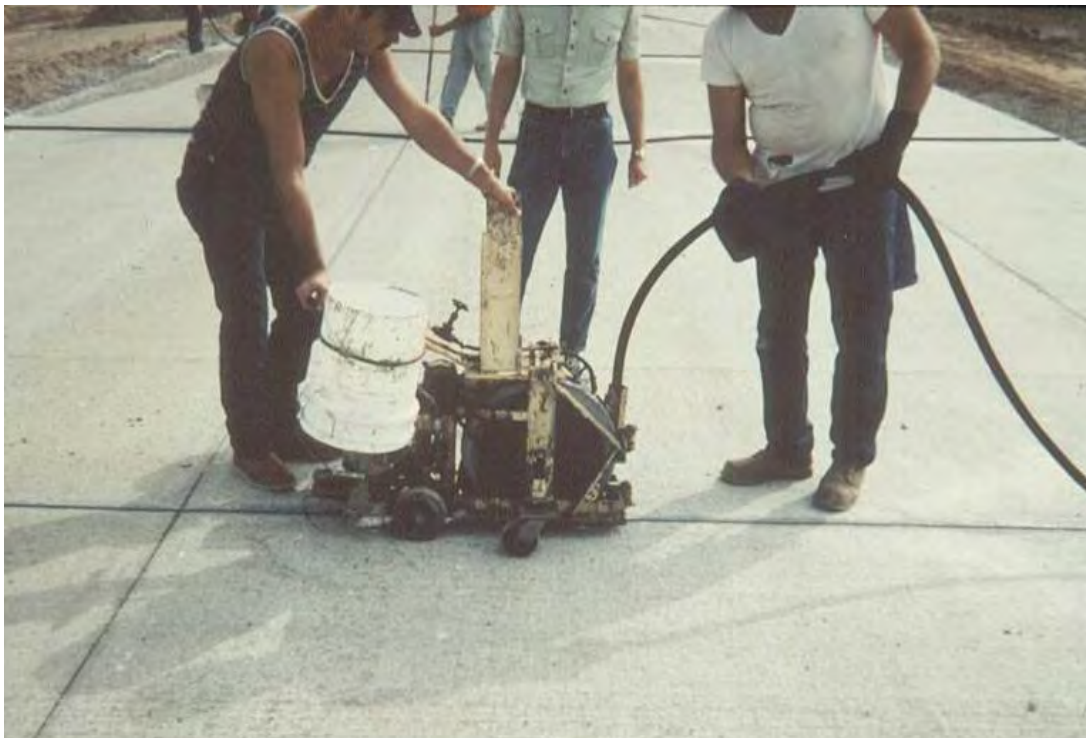

The QA and QC must understand the various types of field molded sealants. Some areas are specified to receive a fuel and blast resistant sealant (touchdown areas), other areas receive a polyurethane (two component) SL or NS and other areas or interfaces may not be identified (interface from HMA to PCC). The field molded sealants, particularly if two component, must follow the manufactures directions on mixing. If not the material does not cure properly additional problems will occur in the future.

4-18.12 Checklist for Joint Reservoir Sawing and Sealing.

General:

- Do not widen until the cure period is over.
- Review joint installation plan prior to start.
- Require test section be accomplished and have experienced inspector on site.
- Remove all backer rod before cutting joints.
- Cut joints to the required width and depth.
- Assure correct depth and consider if pavement is grooved and reservoir chamfers.
- Cut joints to an even width.
- Immediately clean joint after widening with water jet & remove debris.
- Ensure correct sealant is installed in appropriate are (i.e. blast resistant, fuel resistant, pavement type, etc.).
- Ensure sealant is installed during correct temperatures.
- Sand or water blast both sides of joint prior to sealing (multiple passes required to clean both sides).
- Install seal within 3 days of sawing.
- Store sealant in shade and per the manufactures' recommendations.

Pre-Formed:

- Review all joint faces and intersections to ensure no spalls.
- Select correct size of preformed compression seal.
- Insure manufactures' representative be present per contract.
- Install sealant with a manufactures' recommended machine.
- Check to insure 1% elongation is not exceeded.
- Remove and replace seals elongated greater than 2%.

4-19 QC/QA TESTING AND PAY ADJUSTMENTS.

4-19.1 Introduction.

The UFGS 32 13 11 specifies: 1) the Contractor controls the PCC construction process, and 2) the Government performs acceptance testing to determine the amount of payment. The Government's testing is typically performed by the Contractor but it should be observed by a Government representative.

All Contractor quality control and Government quality assurance testing is performed on a pavement lot basis. A pavement lot is equal to one shift of production not to exceed 1000 cubic yards.

4-19.2 Contractor Quality Control (CQC).

Contractor QC sampling, testing, inspection and reporting shall be in accordance with Tables 4-5 through 4-8. All results shall be referenced to the production lot of concrete and submitted on a daily basis.

Table 4-5 CQC Testing Requirements for Materials

| Frequency | Test Method | Control Limit/Corrective Action |
|------------------------------------------------------|-------------------------------|--------------------------------------------------------------------------------------------------------------------------------------------------------------------------------------------------------------------------------|
| Fine Aggregate Gradation and Fineness Modulus | | |
| 2 per lot | ASTM C 136 sample at belt | 9 of 10 tests vary <0.15 from average. - Outside limits on any sieve, retest. - 2nd failure, stop, repair, retest. |
| Coarse Aggregate Gradation | | |
| 2 per lot | ASTM C 136 sample at belt | Outside limits on any sieve-retest. - 2nd failure-report to COR, correct. 2 consecutive avgs. of 5 tests out. - report to COR, stop ops, repair, retest. |
| Workability Factor and Coarseness Factor Computation | | |
| 2 per lot | See UFGS, para: Aggregates | Use individual C.A. and F.A. gradations. Combine using batch ticket percentages. Tolerances from approved mix values: ± 3 points on WF ± 5 points on CF Check batching tolerances, recalibrate scales. |
| Aggregate Deleterious and Quality Tests | | |
| See Specifications | See UFGS, para: Aggregates | Stop production, retest, replace aggregate. Increase testing interval to 90 days if previous 2 tests pass. |

Table 4-6 CQC Testing and Inspection Requirements for Batch Plant

| Frequency | Test Method | Control Limit/Corrective Action |
|--------------------------------------|-----------------|-------------------------------------------------------------------------------------------------------------------------------------------------------|
| Scales, Weighing Accuracy | | |
| Monthly | NRMCA QC 3 | Stop plant ops, repair, recalibrate. |
| Batching and Recoding Accuracy | | |
| Weekly | Record & Report | Record required and actual batch masses. Stop plant ops, repair, recalibrate |
| Batch Plant Control | | |
| Every Lot | Record & Report | Record type/amt of each material per lot. |
| Mixer Uniformity – Stationary Mixers | | |
| Every 4 Months During Paving | Record & Report | After initial approval, use abbreviated method. Increase mixing time, change batching sequence, reduce batch size to bring into compliance. Retest |
| Mixer Uniformity – Truck Mixers | | |
| Every 4 Months During Paving | ASTM C 94 | Random selection of truck. Increase mixing time, change batching sequence, reduce batch size to bring into compliance. Retest. |

The Contractor is required to develop and update control charts for air content, unit weight, slump, temperature and strength. A typical control chart is shown on Figure 4-153. Two limits are provided. The “Warning Limit” is used to alert the Contractor that the trend is heading out-of-control. At this point, the Contractor needs to investigate and correct the problem, but he does not need to stop production. The “Action Limit,” which is outside of the Warning Limit, requires the contractor to stop production, correct the problem, recalibrate the plant, and retest to confirm compliance.

Figure 4-153 Air Content Control Chart 1



**Table 4-7 CQC Testing Requirements for Fresh PCC
(All Samples Taken At the Paving Site)**

| Frequency | Test Method | Control Limit/Corrective Action |
|---------------------------------------------------|-------------------------------------------------|-------------------------------------------------------------------------------------------------------------------------------------------------------------------------------------------------------------------------------------------------------------------------------------|
| Air Content | | |
| When Cyls/Beams Prepared + 2 random | ASTM C 231 | Individual test control chart: - Warning +/-1.0 - adjust AEA, retest. - Action +/-1.5 - halt ops, repair, retest. Range between 2 consecutive tests: - Warning +2.0 - recalibrate AEA dispenser. - Action +3.0 - halt ops, repair, retest. |
| Unit Weight and Yield | | |
| Same as Air content | ASTM C 138 | Individual test basis: - Warning Yield -0/+1%. check batching tolerances. - Action Yield -0/+5% halt ops, recalibrate. |
| Slump | | |
| When Cyls/Beams Prepared + 4 random | ASTM C 143 | Individual test control chart: - Upper Warning - 1/2 inch below max. Adjust batch masses within max WCR. - Upper Action - maximum slump. Stop operations, adjust, retest. Range between each consecutive test: - 1-1/2 inches. Stop operations, repair, retest |
| Temperature | | |
| When Cyls/Beams Prepared | ASTM C 1064 | See specifications paragraph: Weather Limitations. |
| Strength | | |
| 1 Set of 2 Beams or Cylinders Per Sublot | ASTM C 31 and Cyls – C 39 Beams – C 78 | Test specimens at 7 days age. Average all cyls or beams per lot. Convert to 90-day design strength using correlation factor from mix proportioning. If equivalent 90-day strength < design by 20 psi or more, adjust mix proportions. |

Table 4-8 CQC Inspection Requirements for Paving

| Frequency | Test Method | Control Limit/Corrective Action |
|--------------------------------|--------------------|-------------------------------------------------------------------------------------------------------------------------------|
| Before Paving | | |
| Prior to Each Paving Operation | Record & Report | Inspect underlying materials, construction joint faces, forms, reinforcing, dowels, and embedded items |
| During Paving | | |
| During Each Paving Operation | Record & Report | Monitor and control paving operation, including placement, consolidation, finishing, texturing, curing, and joint sawing. |
| Vibrators | | |
| Weekly, During Paving | CRD-C 521 | Test frequency (in concrete), and amplitude (in air), measure at tip/head and average. Repair or replace defective vibrators. |
| Moist Curing | | |
| 2 per Lot | Visual | Repair defects, extend curing by 1 day |
| Membrane Compound Curing | | |
| Daily | Visual | Calculate coverage based on quantity / area. Respray areas where coverage defective, Recalibrate equipment. |
| Cold Weather Protection | | |
| Daily | Visual | Repair defects, report conditions to COR |

4-19.3 Quality Assurance (QA) and Pay Adjustment.

Pay adjustment factors are included in the specification for smoothness, grade, and thickness. When a lot of material fails to meet the specification requirements, that lot will be accepted at a reduced price or shall be removed and replaced. The lowest computed percent payment determined for any pavement characteristic discussed below shall be the actual percent payment for that lot. The percent payment will be applied to the unit price and the measured quantity of concrete in the lot to determine actual payment.

Edge slump and joint face deformation (for pilot lanes of slipformed pavement) and flexural strength are measured for each pavement lot, but are not paid with a payment adjustment. Pavements failing in edge slump, joint face deformation, or flexural strength shall be removed and replaced.

4-19.3.1 Smoothness. Procedures and equipment for smoothness testing are described in Section 4-16. Smoothness is evaluated on a total lot basis, sublots are not considered. The payment adjustment factors for pavements not meeting the smoothness requirements is on a sliding scale, i.e., the rougher the pavement surface, the larger the payment reduction. The payment adjustment factors are presented in Table 4-9 (for straightedge measurements) and Table 4-10 (for California profilograph measurements).

**Table 4-9 Payment Adjustment Factor for Smoothness
(Using a Straightedge)**

| Observations Outside Limits (%) | Payment Adjustment Factor (%) |
|------------------------------------|----------------------------------|
| Less than 5.0 | 100 |
| 5.1 - 10.0 | 95 |
| 10.1 - 15.0 | 90 |
| 15.1 - 20.0 | 75 |
| Greater than 20.1 | Remove |

**Table 4-10 Payment Adjustment Factor for Smoothness
(Per 0.1 Mile segment, Using a California Profilograph)**

| Profile Index Outside Limits (inches / mile) | Payment Adjustment Factor (%) |
|-------------------------------------------------|----------------------------------|
| Less than 1.0 | 100 |
| 1.0 – 1.9 | 95 |
| 2.0 – 2.9 | 90 |
| 3.0 – 3.9 | 75 |
| Greater than 4.0 | Remove |

4-19.3.2 Grade. Procedures and equipment for grade testing are described in Section 4-16. Grade is determined on a total lot basis, sublots are not considered.

The payment adjustment factor for pavements not meeting the grade requirements is on a sliding scale. The payment adjustment factors are presented in Table 4-11.

4-19.3.3 Thickness. Thickness is determined on a subplot basis, with four sublots in a lot. Two cores, between 4 and 6 inches, shall be drilled from the pavement, per subplot (8 per lot). Locations should be randomly selected in accordance with ASTM D 3665. Core holes shall be backfilled with a rapid-setting, non-shrink concrete.

Table 4-11 Payment Adjustment Factor for Grade

| Grade Shots Outside Tolerance (%) | Payment Adjustment Factor (%) |
|-----------------------------------|-------------------------------|
| 5.0 or less | 100 |
| 5.1 – 10.0 | 95 |
| 10.1 – 50.0 | 75 |
| More than 50.0 | Remove |

Note: Tolerances from plan grade are ½ inch (0.01 foot). See Chapter 4-16.

The core surfaces should be observed for evidence of excess paste, segregation, and honeycombing as indicators of mix or placement deficiencies. Eight measurements of thickness shall be made around the circumference of each core and one in the center, in accordance with ASTM C 174, using calibrated calipers for specimens longer than 10 inches. The pavement thickness from the 8 cores for the lot shall be averaged and the payment adjustment factor shall be determined from Table 4-12.

Table 4-12 Payment Adjustment Factor for Thickness

| Thickness Deficiency (inches) | Payment Adjustment Factor (%) | |
|---------------------------------|---------------------------------|---------------------------|
| | Design Thickness ≥ 8 ins. | Design Thickness < 8 ins. |
| 0.00 – 0.24 | 100 | 100 |
| 0.25 – 0.49 | 75 | 65 |
| 0.50 – 0.74 | 50 | 0 |
| 0.75 or Greater | 0 | 0 |

Where 0 percent payment is indicated, the entire lot shall be removed and replaced at no additional cost to the Government. Where either of the two cores from a subplot show a thickness deficiency of 0.75 inch or greater, two more cores shall be drilled in the subplot and the average thickness of the four cores computed. If this average shows a thickness deficiency of 0.75 inch or more (0.50 inch for pavements 8 inches or less in thickness), the entire subplot shall be removed.

4-19.3.4 Edge Slump and Joint Face Deformation. Edge slump is described in Section 4-11 and a photograph is shown on Figure 4-83. These measurements are applicable only to slipform paving operations.

Immediately after the concrete has hardened sufficiently to permit walking thereon, the pavement surface of each lot shall be tested by the Contractor.

Testing shall be performed with a minimum 12 foot straightedge to reveal irregularities exceeding the edge slump tolerance specified in Table 4-13.

The vertical edge slump shall be determined at each free edge of each slipformed paving lane constructed. The straightedge shall be placed transverse to the direction of paving and the end of the straightedge located at the edge of the paving lane. (A pavement panel is defined as a lane width by the length between two adjacent transverse contraction joints. The total free edge of the pavement will be considered to be the cumulative total linear measurement of pavement panel edge originally constructed as that is not adjacent to any existing pavement; i.e., 100 feet of pilot lane originally constructed as a separate lane, will have 200 feet of free edge; 100 feet of fill-in lane will have no free edge, etc.) The area affected by the downward movement of the concrete along the pavement edge shall not exceed 18 inches back from the edge.

Measurements shall be made at 5 to 15 foot spacings, as directed, commencing at the header where paving was started. Initially measurements shall be made at 5 foot intervals in each lane. When no deficiencies are present, the Contracting Officer may approve an increase in the interval. When any deficiencies exist, the interval will be returned to 5 feet. In no case shall the interval exceed 15 feet. The measurements shall be made by the Contractor, shall be properly referenced in accordance with paving lane identification and stationing, and a report given to the Contracting Officer within 24 hours after measurement is made.

Table 4-13 Edge Slump Limits (Per Each Pavement Panel)

| Tolerance Limits (inches) | Observations Outside Tolerances (%) |
|----------------------------------------|------------------------------------------------------|
| 1/4 | 15 max |
| 3/8 | 0 |

When edge slump exceeding the limits specified above is encountered on either side of the paving lane, additional straightedge measurements shall be made, if required, to define the linear limits of the excessive slump. The concrete slabs having excessive edge slump or joint deformation shall be removed and replaced to the next transverse joint.

Use of slipform paving equipment and procedures that fail to consistently provide edges within the specified tolerances on edge slump and joint face deformation shall be discontinued and the pavements shall be constructed by means of standard paving procedures using fixed forms.

Joint face deformation is a measure of straightness and plumbness of the vertical face of a slipformed pilot lane. The required measurements and their tolerances

are presented in Table 4-14. Drawings of the layout for each measurement are presented in Figures 4-154 through 4-157.

Table 4-14 Joint Face Deformation Tolerances

| Offset From Straightedge | Figure | Maximum Tolerances |
|------------------------------------|--------|----------------------|
| Longitudinally to Pavement Surface | 20.2 | 1/8 inch |
| Longitudinally to Vertical Face | 20.3 | 1/4 inch |
| Top to Bottom Along Vertical Face | 20.4 | 3/8 inch |
| Abrupt offset in any direction | 20.3 | 1/8 inch |
| Batter from true vertical | 20.5 | 1 inch per 12 inches |

Longitudinal straight edging should be performed as shown in Figures 4-154 and 4-155. The 12-foot straightedge should be advanced one-half its length for each reading to provide continuous coverage along the pavement surface and joint face.

Measurements of the plumbness of the vertical face should be conducted at the same frequency as for transverse edge slump testing.

Figure 4-154 Measuring Offset From Straightedge Applied Longitudinally to Pavement Surface

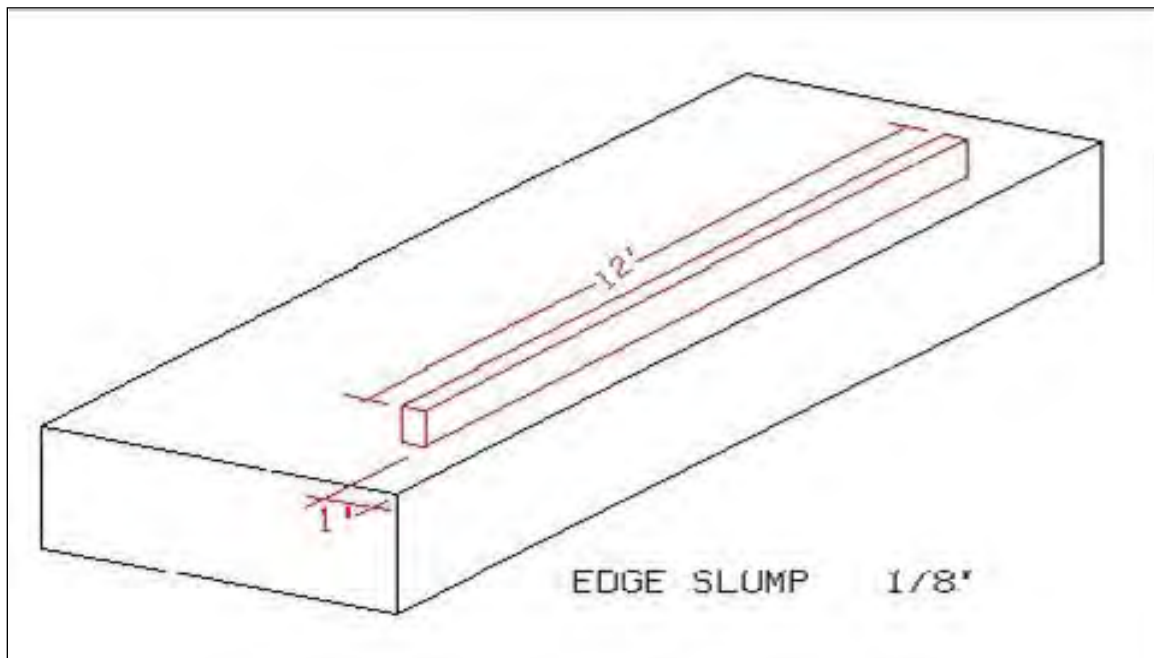

Figure 4-155 Measuring Offset From Straightedge Applied Longitudinally to Vertical Face

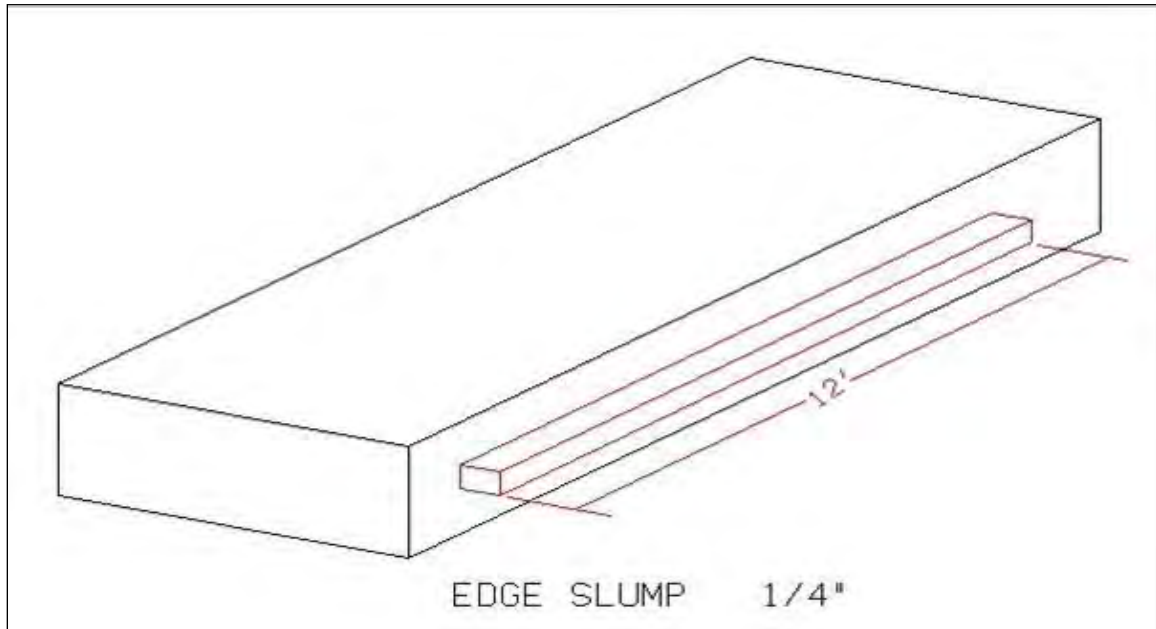

Figure 4-156 Measuring Offset From Straightedge Applied Top to Bottom Against the Joint Face

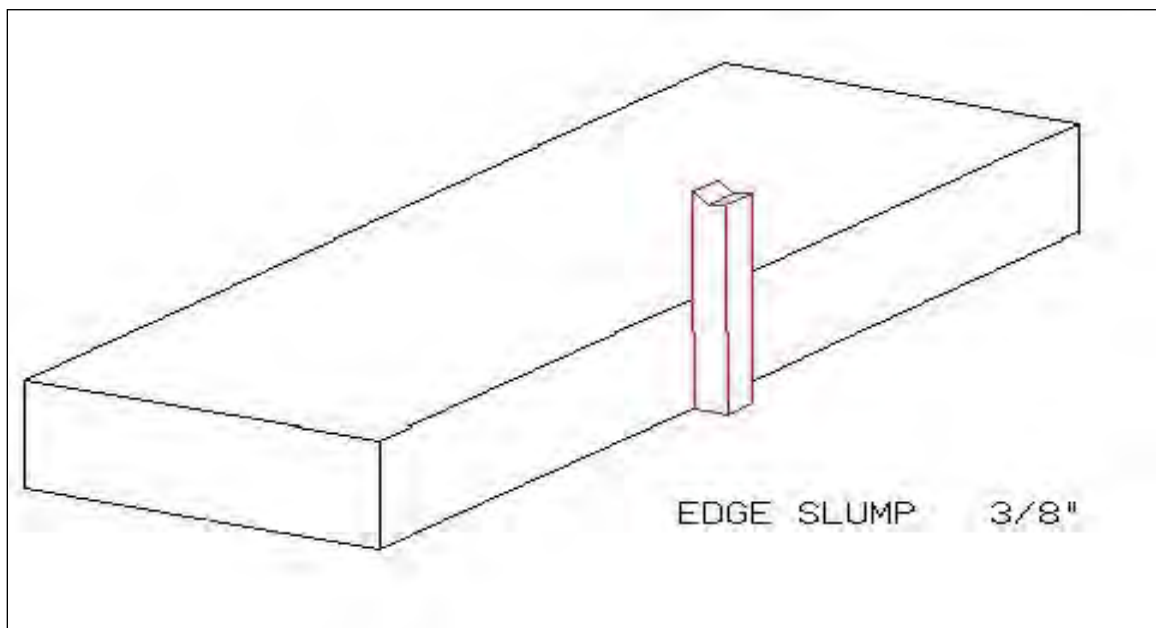
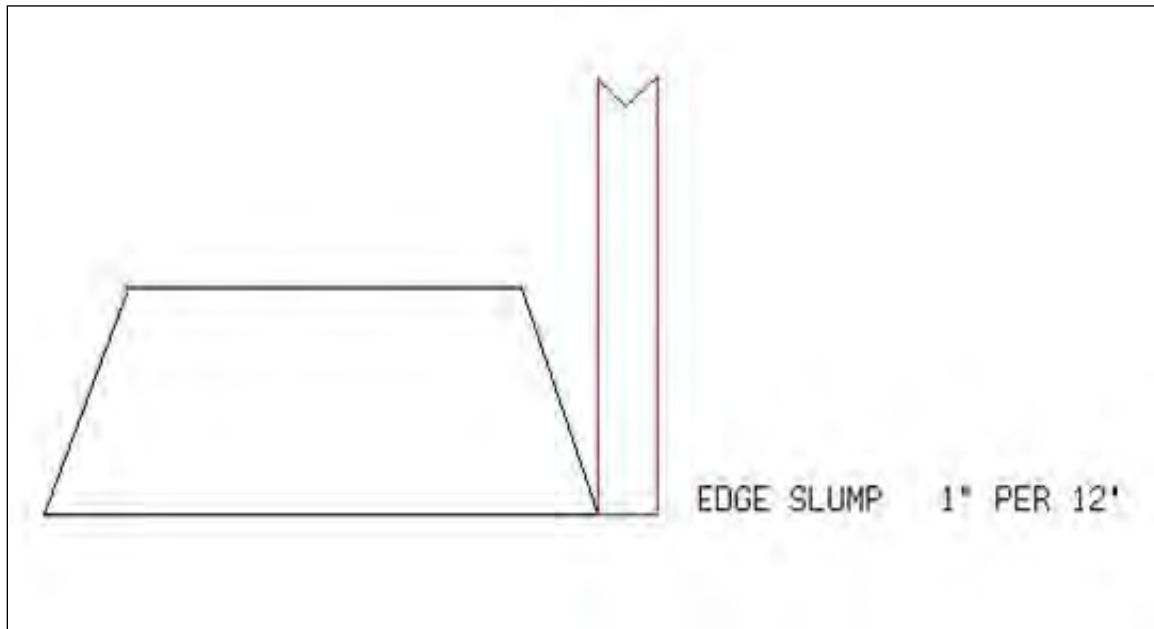

Figure 4-157 Measuring Offset of Joint Face from True Vertical



Joint face deformation exceeding the limits of Table 4-14 shall be repaired by removal and replacement of the deficient slabs. Minor irregularities may be removed by diamond saw cutting the full depth of the vertical face (Figure 4-158). Extensive saw cutting will require transitioning the saw cut over several hundred feet of joint length to match the longitudinal joint pattern.

Figure 4-158 Saw Cutting Vertical Joint Face



4-19.3.5 Flexural Strength. Flexural strength is accepted on the basis of cylinders or beams tested at 14-days of age and correlated to the 90 day design strength, using the correlation factor determined during the mix proportioning phase (Section 4-4). The designer will specify either beams or beams/cylinders for use in the mix proportioning, CQC testing, and QA acceptance.

Each lot of pavement will be evaluated for acceptance in accordance with the following procedures:

- One composite sample of concrete from each subplot shall be obtained in accordance with ASTM C 172 from one batch or truckload deposited in front of the paver.
- Test cylinders 6 x 12 inches shall be fabricated and cured in accordance with ASTM C 31 and tested in accordance with ASTM C 39.
- Test beams 6 x 6 inches shall be fabricated in steel beam molds, cured in accordance with ASTM C 31, and tested in accordance with ASTM C 78.
- Test cylinders or beams (eight per lot) at 14 days of age.
- Average the eight 14-day strength tests for the lot.
- Apply the Correlation Factor determined during the mix proportioning to determine the average equivalent 90 day flexural strength.
- The strength of the concrete will be considered acceptable when the average equivalent 90-day flexural strengths for each lot are above the design requirement and no individual set (2 specimens per subplot) in the lot are 25 psi or more below the equivalent design requirement.

If any lot or subplot, respectively, fails to meet the above criteria, the lot or subplot shall be removed and replaced at no additional cost to the Government.

4-19.4 Compliance Checklist.

- CQC Documentation:
 - CQC reports keyed to production lot number.
 - Reports furnished for materials testing, batch plant inspection, fresh PCC, and placement operations at the required frequency.
- QA Testing:
 - All results completed and reported within 5 days after lot placement.
 - Profilograph and straightedge results at frequency required by the specifications.
 - Areas required grinding identified.
 - Grade results performed on a 25-foot grid spacing.
 - Edge slump and joint face deformation test conducted at required spacing.
 - Areas requiring repair identified.
 - Strength test results are provided.
- Remedial Actions:
 - Areas requiring grinding are ground and retested for smoothness and grade.
 - Areas requiring removal and replacement are completed and retested.

4-20 IDENTIFICATION AND CAUSE OF HARDENED PCC DISTRESS.

4-20.1 Introduction.

This chapter reviews the causes of various types of distress in hardened PCC caused by construction-related activities. These distresses may be present at the conclusion of paving operations or may be observed during the subsequent 12-month warranty period.

Distresses in fresh concrete, which are observed during the paving operations, have been discussed in Sections 4-11 through 4-14.

4-20.2 Plastic Shrinkage Cracks.

4-20.2.1 Cause. Plastic shrinkage cracks (Figure 4-159) are the result of weather factors (high air temperature, low humidity, and high wind speed) which cause the PCC surface to set before the bleed water from the interior of the slab has migrated to the surface. This results in a series of discontinuous, short cracks, generally perpendicular to the direction of paving. Plastic shrinkage cracks can occur in both slipform and fixed form paving operations.

Figure 4-159 Plastic Shrinkage Cracking



The potential for plastic shrinkage cracking can be assessed by using the nomograph of ACI 305R (Figure 4-122). The variables needed to use this nomograph include concrete temperature, ambient air temperature, humidity, and wind speed. The concrete temperature can be determined in accordance with ASTM C 1064, while the air speed, temperature, and humidity can be determined using hand held equipment. The air variables should be measured close to the surface of the pavement. The rate of evaporation should be less than 0.20 pounds per square foot per hour (lb/sq ft/hr).

If plastic shrinkage cracking occurs, halt further placement of concrete until protective measures are in place to prevent further cracking. The concrete placement shall be further protected by erecting shades and windbreaks and by applying fog sprays of water, the addition of monomolecular films, or wet covering. When such water treatment is stopped, curing procedures shall be immediately commenced.

4.20.2.2 Repair. Determine whether cracks extend full depth of the pavement by coring on the crack. Cores shall be at least 6-inches in diameter, and shall be drilled and backfilled with a well-consolidated concrete mixture bonded to the walls of the hole with ASTM C 881, Type V, Grade 3 epoxy resin.

Cracks that do not exceed 25 percent of the design thickness in depth shall be cleaned and then pressure injected full depth with epoxy resin, ASTM C 881,

Type IV, Grade 1. Slabs containing cracks deeper than 25 percent of the design thickness shall be removed.

4-20.3 Spalling.

Spalls are chipped pieces of hardened concrete that range in size from small thumb-nail to large plate-size pieces (Figure 4-160). They generally occur along sawn, longitudinal and transverse joint lines.

Figure 4-160 Spalls along Joint Line



4-20.3.1 Causes. On longitudinal joints, spalling is generally caused by over finishing the joint edge and creating a high WCR paste, which is non-durable (Figure 4-161). This distress may be present on one or both sides of the joint, depending on the mix design and construction practices used. The common feature is the use of a water spray to make the concrete mortar more workable.

Figure 4-161 Over Finishing Edge of Pilot Lane



On transverse joints, spalling is generally caused by over finishing the pavement surface with a bullfloat, which again creates a high WCR paste, which is non-durable.

Spalls can also be created by the joint sawing operation. The wrong type of saw blade for the aggregate, a dull blade, or “crowding” the saw (i.e., pushing the saw blade, rather than letting the blade pull the saw through the concrete) can lead to small spalls all along the sawn joint.

4-20.3.2 Repair.

Not more than 15.0 percent of each slab's longitudinal joint edge shall be spalled. Slabs with spalls exceeding this quantity, regardless of spall size, shall be sawn full depth to remove the spalled face (on pilot-lanes), or these slabs shall be removed.

Spall repair is a time-consuming, manual process and is best avoided by enforcing good construction practices while the concrete is fresh. Spall repair materials and practices are described in UFC 3-270-03 and 3-270-04 and are summarized below:

- Spalls shall be repaired by first making a vertical saw cut at least 1 inch outside the spalled area and to a depth of at least 2 inches. Saw cuts shall be straight lines forming rectangular areas.
- The concrete between the saw cut and the joint shall be chipped out to remove all unsound concrete. The saw cut shall be made into at least 1/2 inch of visually sound concrete. Spalls along joints to be sealed with compression seals shall be sawn, chipped out, and repaired to a depth to restore the full joint-face support.
- The cavity shall be thoroughly cleaned with high pressure water jets supplemented with oil-free compressed air to remove all loose material.
- Immediately before filling the cavity, a prime coat shall be applied to the dry cleaned surface of all sides and bottom of the cavity, except any joint face. The prime coat shall be applied in a thin coating and scrubbed into the surface with a stiff-bristle brush. Prime coat for portland cement repairs shall be a neat cement grout and for epoxy resin repairs shall be epoxy resin, ASTM C 881, Type III, Grade 1.
- The prepared cavity shall be filled with concrete or mortar, as described in Table 4-15. Portland cement concretes and mortars shall be very low slump mixtures, 1/2 inch slump or less, proportioned, mixed, placed, consolidated by tamping, and cured, all as directed. Epoxy resin mortars shall be made with ASTM C 881, Type III, Grade 1, epoxy resin, using proportions and mixing and placing procedures as recommended by the manufacturer and approved by the Contracting Officer. Proprietary patching materials may be used, subject to approval.
- The epoxy resin materials shall be placed in the cavity in layers not over 2 inches thick. The time interval between placement of additional layers shall be such that the temperature of the epoxy resin material does not exceed 140 degrees F at any time during hardening.
- Mechanical vibrators and hand tampers shall be used to consolidate the concrete or mortar.
- Any repair material on the surrounding surfaces of the existing concrete shall be removed before it hardens.
- Where the spalled area abuts a joint, an insert or other bond-breaking medium shall be used to prevent bond at the joint face. A reservoir for the joint sealant shall be sawed to the dimensions required for other joints. The reservoir shall be thoroughly cleaned and then sealed with the sealer specified for the joints.
- Cure concrete with moist burlap for 24 hours, then spray curing compound and protect for six days.

Table 4-15 Selection of Spall Repair Material

| Repair Material | Repair Volume (cubic inches) | |
|------------------------------------------------------------|---------------------------------------|---------------------|
| | Minimum | Maximum |
| Portland Cement Concrete, or Latex Modified Concrete | 600 in ³ | -- |
| Portland Cement Mortar | 50 in ³ | 600 in ³ |
| Epoxy-Resin Mortar, or Latex-Modified Mortar | -- | 50 in ³ |
| Proprietary Cementitious Products | Per Manufacturer's Recommendations | |

4-20.4 Weak Surfaces.

4-20.4.1 Cause. Weak surfaces are defined as mortar-rich (deficient in plus U.S. No. 4 sieve size aggregate), rain-damaged, uncured, or containing exposed voids or deleterious materials.

4-20.4.2 Repair. Slabs containing weak surfaces less than 1/4 inch (6 mm) thick shall be diamond ground to remove the weak surface. Diamond grinding shall be in accordance with paragraph 4-16.4, Diamond Grinding. Slabs containing weak surfaces greater than 1/4 inch (6 mm) thick shall be removed and replaced.

4-20.5 Slab Removal and Replacement

Slabs containing defects other than described above shall be removed and replaced. Removal and replacement shall be full depth, by full width of the slab, and the limit of removal shall be normal to the paving lane and extend to each original joint.

4-20.5.1 Removal. The joint between the removal area and adjoining pavement to stay in place shall first be cut full depth with a standard diamond-type concrete saw.

Next, a full depth saw cut shall be made parallel to the joint at least 24 inches from the joint and at least 6 inches from the end of any dowels. This saw cut shall be made with a wheel saw (Figure 4-162).

All pavement to be removed inside this kerf-saw cut shall be removed in accordance with the approved demolition work plan.

All pavement between the kerf-saw cut and the diamond-blade saw cut shall be removed by carefully pulling pieces and blocks away from the joint face with suitable equipment and then picking them up for removal.

In lieu of the above specified removal method, the slab may be sawcut full depth to divide it into several pieces and each piece lifted out and removed. Suitable

equipment shall be used to provide a truly vertical lift, and safe lifting devices used for attachment to the slab.
See Chapter 8 for more information.

Figure 4-162 Double Saw Cut

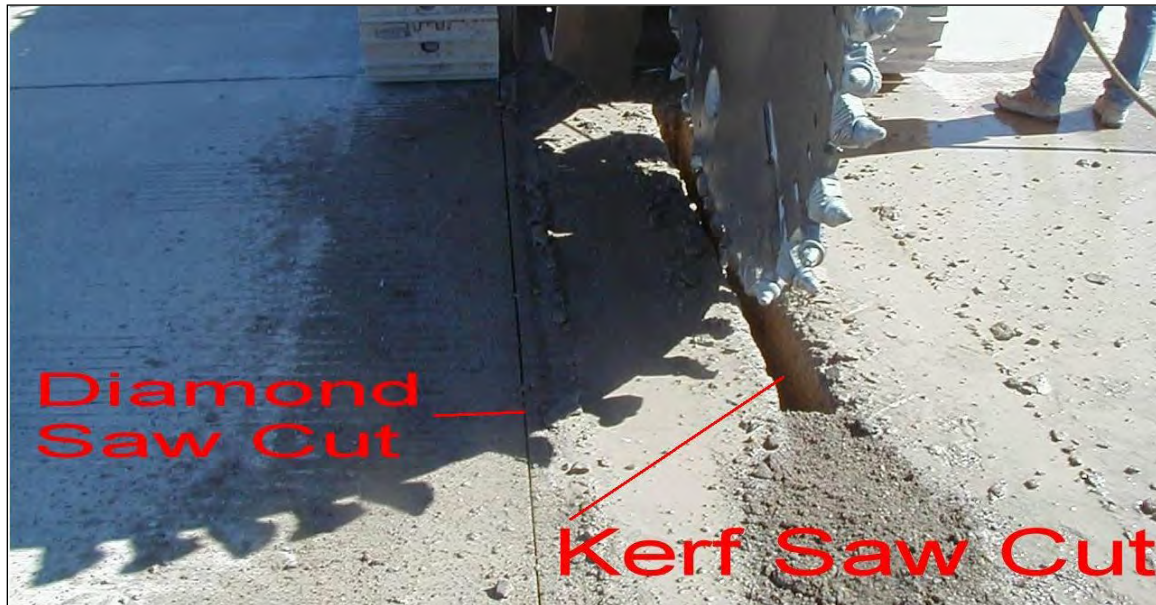

4-20.5 Replacement.

Dowels of the size and spacing as specified for other joints in similar pavement shall be installed by epoxy grouting them into holes drilled into the existing concrete using procedures described in Section 4-8. Original damaged dowels or tie bars shall be cut off flush with the joint face. Protruding portions of dowels shall be painted and lightly oiled. All four edges of the new slab shall thus contain dowels.

Prior to placement of new concrete, the underlying material shall be recompact and shaped as specified and the surfaces of all four joint faces shall be cleaned of all loose material and contaminants and coated with a double application of membrane forming curing compound as bond breaker. Care shall be taken to prevent any curing compound from contacting dowels or tie bars.

Placement of concrete shall be as specified for original construction.

The resulting joints around the new slab shall be prepared and sealed as specified for original construction.

4-20.6 Compliance Checklist.

- Plastic Shrinkage Cracks:
 - Stop all paving operations until conditions are identified and corrected.
 - Verify ACI 3305R nomograph is being used and preventative measures are available and implemented.
 - Core to determine depth of cracks.
 - Epoxy inject shallow cracks, remove slabs with deeper cracks.
- Spalling:
 - Identify cause and establish corrective measures for subsequent paving.
 - Repair spalls
 - Maintain curing for seven days. Verify burlap is maintained wet over the first 24 hours.
- Weak Surfaces:
 - Identify and correct cause.
 - Diamond grind or remove slab, depending on depth of distress.
- Slab Removal and Replacement:
 - Remove full depth by full slab area.
 - Use double-saw cut method.
 - Install new dowels and prepare base course.
 - Place, consolidate, finish and cure concrete.
 - Saw new sealant reservoir.